

# ダーリントン

# 2SB1382

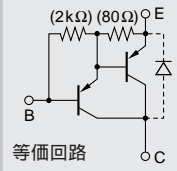

シリコンPNPエビタキシャルプレーナ型トランジスタ(2SD2082とコンプリメンタリ)

用途: チョッパレギュレータ、DCモータ駆動、一般用

絶対最大定格 (Ta=25)

記号	規格値	単位
V <sub>CB0</sub>	-120	V
V <sub>CE0</sub>	-120	V
V <sub>EB0</sub>	-6	V
I <sub>c</sub>	-16(パルス - 26)	A
I <sub>B</sub>	-1	A
P <sub>c</sub>	75(T <sub>c</sub> =25)	W
T <sub>j</sub>	150	
T <sub>stg</sub>	-55 ~ +150	

電気的特性 (Ta=25)

記号	試験条件	規格値	単位
I <sub>CB0</sub>	V <sub>CB</sub> = -120V	-10max	μA
I <sub>EB0</sub>	V <sub>EB</sub> = -6V	-10max	mA
V(BR) <sub>CEO</sub>	I <sub>c</sub> = -10mA	-120min	V
h <sub>FE</sub>	V <sub>CE</sub> = -4V, I <sub>c</sub> = -8A	2000min	
V <sub>CE(sat)</sub>	I <sub>c</sub> = -8A, I <sub>B</sub> = -16mA	-1.5max	V
V <sub>BE(sat)</sub>	I <sub>c</sub> = -8A, I <sub>B</sub> = -16mA	-2.5max	V
f <sub>T</sub>	V <sub>CE</sub> = -12V, I <sub>E</sub> = 1A	50typ	MHz
C <sub>OB</sub>	V <sub>CB</sub> = -10V, f = 1MHz	350typ	pF

外形図 FM100(TO3PF)

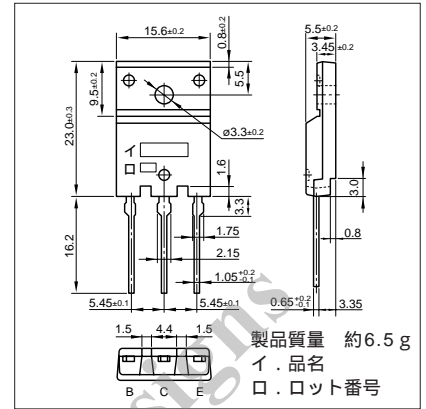

代表的スイッチング特性 (エミッタ接地)

V <sub>CC</sub> (V)	R <sub>L</sub> (Ω)	I <sub>c</sub> (A)	V <sub>BB1</sub> (V)	V <sub>BB2</sub> (V)	I <sub>B1</sub> (mA)	I <sub>B2</sub> (mA)	t <sub>on</sub> (μs)	t <sub>stg</sub> (μs)	t <sub>f</sub> (μs)
-40	5	-8	-10	5	-16	16	0.8typ	1.8typ	1.0typ

I<sub>c</sub>-V<sub>CE</sub>特性 (代表例)

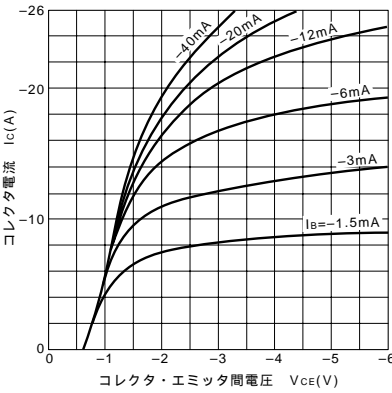

V<sub>CE(sat)</sub>-I<sub>B</sub>特性 (代表例)

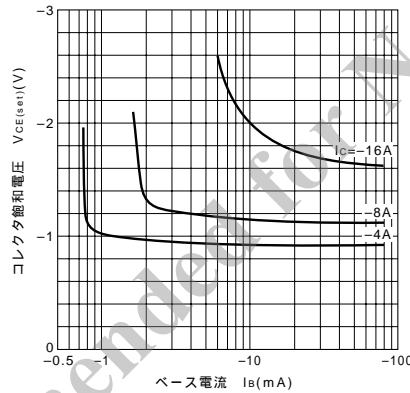

I<sub>c</sub>-V<sub>BE</sub>温度特性 (代表例)

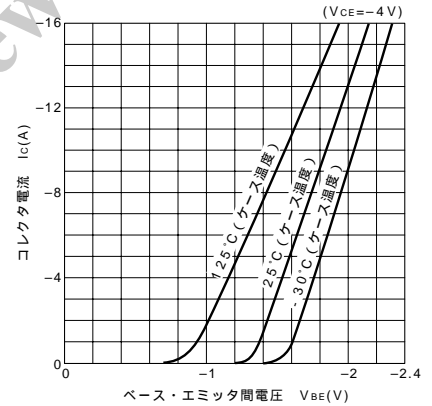

h<sub>FE</sub>-I<sub>c</sub>特性 (代表例)

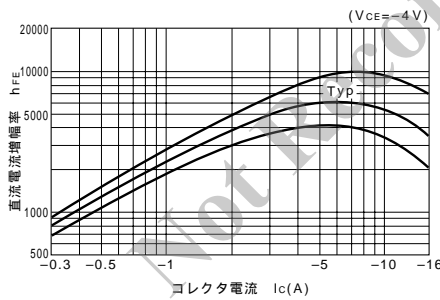

h<sub>FE</sub>-I<sub>c</sub>温度特性 (代表例)

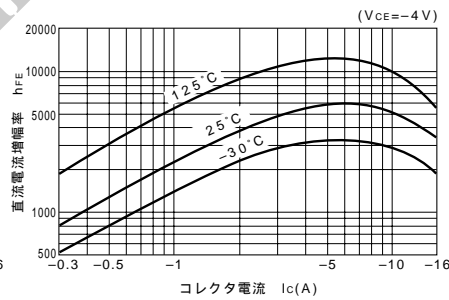

θ<sub>j-a</sub>-t特性

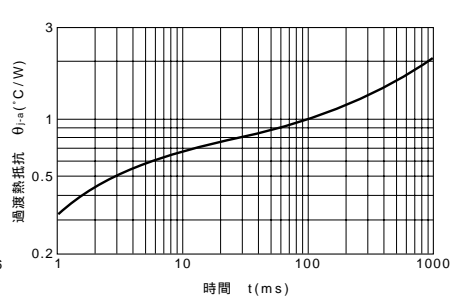

f<sub>T</sub>-I<sub>E</sub>特性 (代表例)

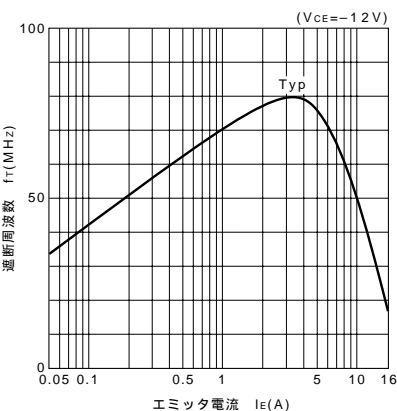

ASO曲線 (単発パルス)

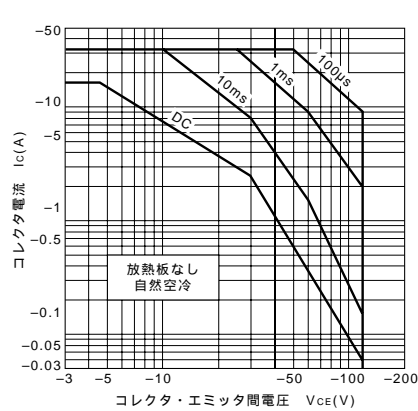

P<sub>c</sub>-T<sub>a</sub>定格

