

ダーリントン

2SB1587

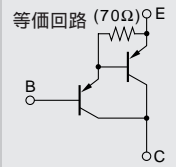

シリコンPNPエビタキシャルプレーナ型トランジスタ(2SD2438とコンプリメンタリ)

用途：オーディオ、シリーズレギュータ、一般用

絶対最大定格 (Ta=25)

記号	規格値	単位
V _{CB0}	-160	V
V _{CEO}	-150	V
V _{EBO}	-5	V
I _C	-8	A
I _B	-1	A
P _C	75(T _C =25)	W
T _J	150	
T _{stg}	-55 ~ +150	

電気的特性 (Ta=25)

記号	試験条件	規格値	単位
I _{CB0}	V _{CB} = -160V	-100max	μA
I _{EBO}	V _{EB} = -5V	-100max	μA
V(BR)CEO	I _C = -30mA	-150min	V
h _{FE}	V _{CE} = -4V, I _C = -6A	5000min	
V _{CE(sat)}	I _C = -6A, I _B = -6mA	-2.5max	V
V _{BE(sat)}	I _C = -6A, I _B = -6mA	-3.0max	V
f _T	V _{CE} = -12V, I _E = 1A	65typ	MHz
C _{OB}	V _{CB} = -10V, f = 1MHz	160typ	pF

外形図 FM100(TO3PF)

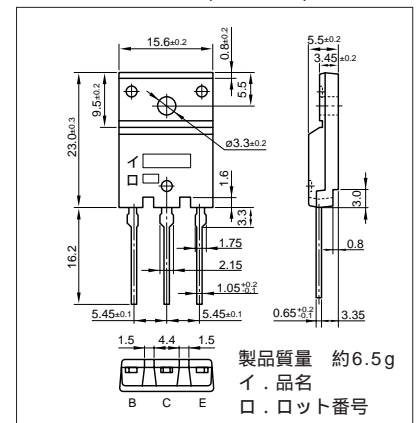

代表的スイッチング特性 (エミッタ接地)

V _{CC} (V)	R _L (Ω)	I _C (A)	V _{BB1} (V)	V _{BB2} (V)	I _{B1} (mA)	I _{B2} (mA)	t _{on} (μs)	t _{stg} (μs)	t _f (μs)
-60	10	-6	-10	5	-6	6	0.7typ	3.6typ	0.9typ

I_C-V_{CE}特性 (代表例)

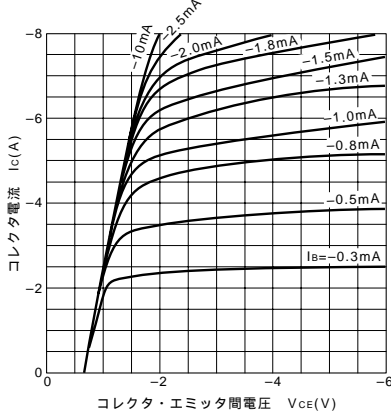

V_{CE(sat)}-I_B特性 (代表例)

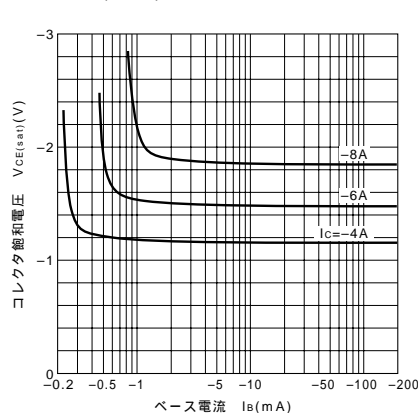

I_C-V_{BE}温度特性 (代表例)

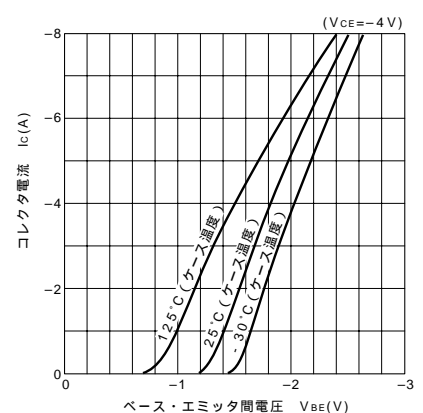

h_{FE}-I_C特性 (代表例)

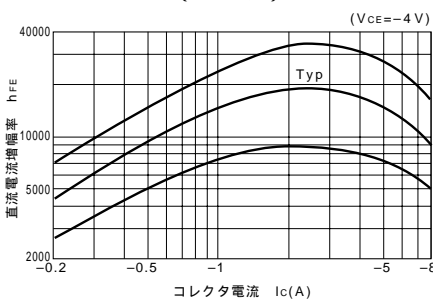

h_{FE}-I_C温度特性 (代表例)

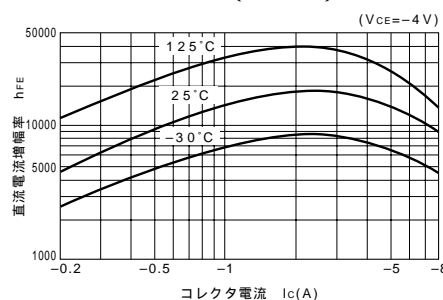

θ_{J-a}-t特性

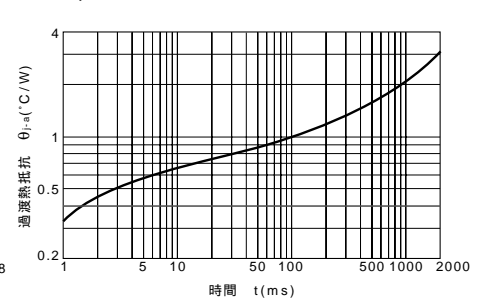

f_T-I_E特性 (代表例)

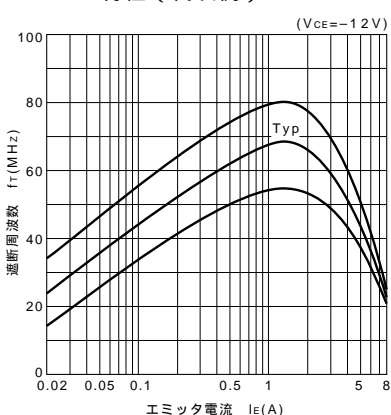

ASO曲線 (単発パルス)

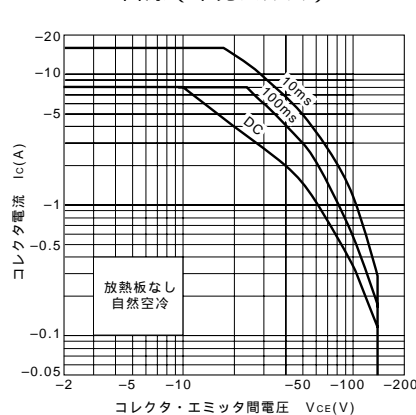

P_C-T_a定格

