

2SC3927

シリコンNPN三重拡散プレーナ型トランジスタ (高耐压スイッチングトランジスタ)

用途：スイッチングレギュレータ、一般用

絶対最大定格 (Ta = 25)

記号	規格値	単位
VcBO	900	V
VCEO	550	V
VEBO	7	V
Ic	10(パルス15)	A
Ib	5	A
Pc	120(Tc = 25)	W
Tj	150	
Tstg	- 55 ~ + 150	

電気的特性 (Ta = 25)

記号	試験条件	規格値	単位
IcBO	VcB = 800V	100max	μA
IEBO	VEB = 7V	100max	μA
V(BR)CEO	Ic = 10mA	550min	V
hFE	VCE = 4V, Ic = 5A	10 ~ 28	
VCE(sat)	Ic = 5A, Ib = 1A	0.5max	V
VBE(sat)	Ic = 5A, Ib = 1A	1.2max	V
fr	VCE = 12V, IE = - 1A	6typ	MHz
COB	VcB = 10V, f = 1MHz	105typ	pF

外形図 MT-100(TO3P)

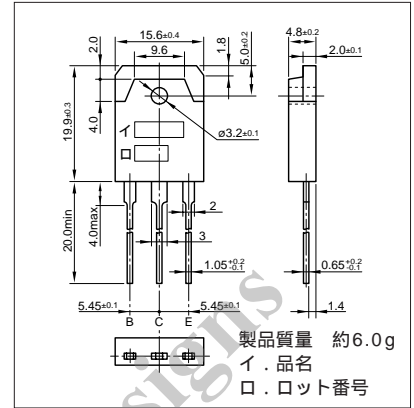

代表的スイッチング特性 (エミッタ接地)

Vcc (V)	RL (Ω)	Ic (A)	VBB1 (V)	VBB2 (V)	Ib1 (A)	Ib2 (A)	ton (μs)	tstg (μs)	tf (μs)
250	50	5	10	-5	0.75	-1.5	1max	5max	0.5max

Ic-VCE特性 (代表例)

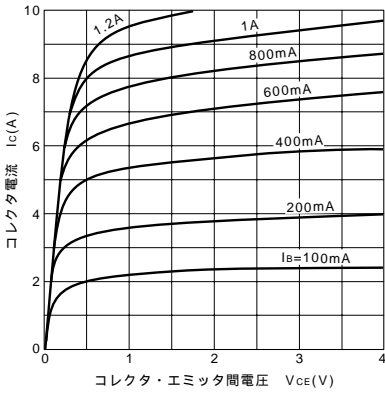

VCE(sat), VBE(sat)-Ic温度特性(代表例)

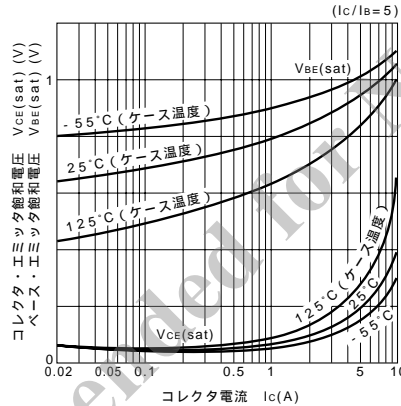

Ic-VBE温度特性 (代表例)

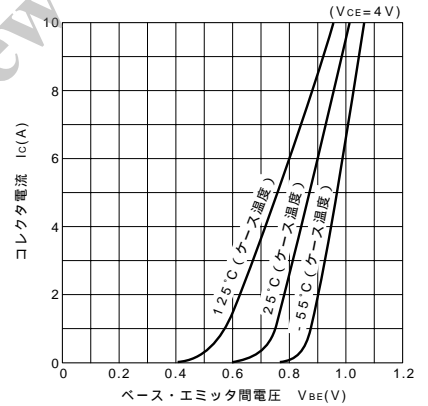

hFE-Ic温度特性 (代表例)

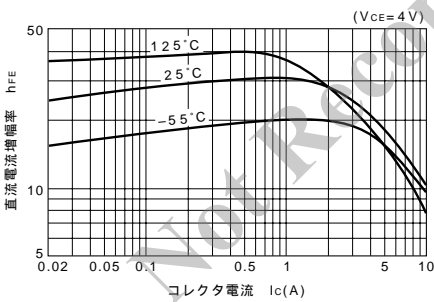

ton•tstg•tf-Ic特性 (代表例)

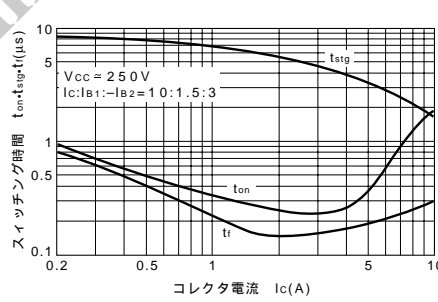

θj-a-t特性

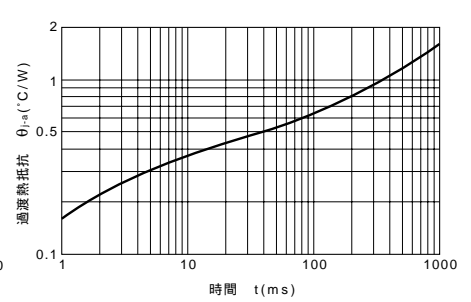

ASO曲線 (単発パルス)

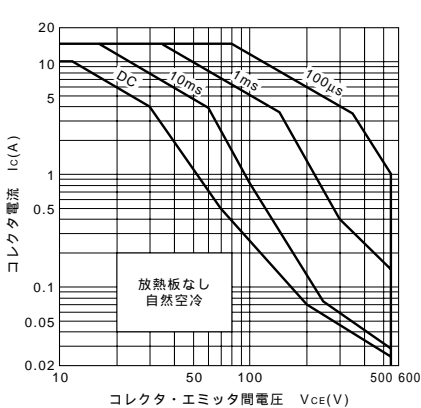

逆バイアスASO曲線

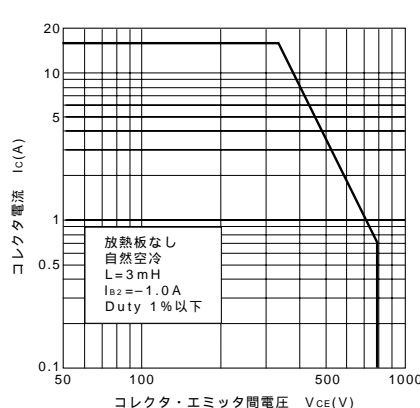

Pc-Ta定格

