

ダーリントン 2SD2390

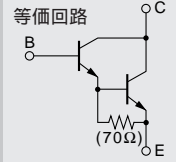

シリコンNPN三重拡散プレーナ型トランジスタ(2SB1560とコンプリメンタリ)

用途：オーディオ、シリーズレギュレータ、一般用

絶対最大定格 (Ta=25)

記号	規格値	単位
V _{CB0}	160	V
V _{CEO}	150	V
V _{EBO}	5	V
I _C	10	A
I _B	1	A
P _C	100(Tc=25)	W
T _J	150	
T _{stg}	-55 ~ +150	

電気的特性 (Ta=25)

記号	試験条件	規格値	単位
I _{CB0}	V _{CB} = 160V	100max	μA
I _{EBO}	V _{EB} = 5V	100max	μA
V _{(BR)CEO}	I _C = 30mA	150min	V
h _{FE}	V _{CE} = 4V, I _C = 7A	5000min	
V _{CE(sat)}	I _C = 7A, I _B = 7mA	2.5max	V
V _{BE(sat)}	I _C = 7A, I _B = 7mA	3.0max	V
f _r	V _{CE} = 12V, I _E = -2A	55typ	MHz
C _{OB}	V _{CB} = 10V, f = 1MHz	95typ	pF

外形図 MT-100(T03P)

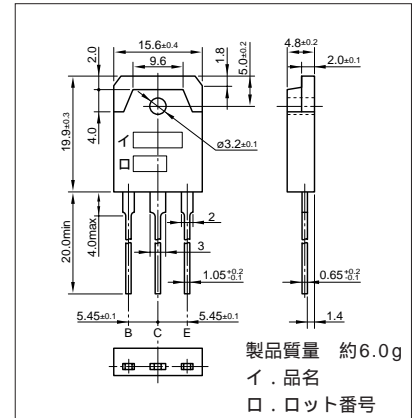

代表的スイッチング特性 (エミッタ接地)

V _{CC} (V)	R _L (Ω)	I _C (A)	V _{BB1} (V)	V _{BB2} (V)	I _{B1} (mA)	I _{B2} (mA)	t _{on} (μs)	t _{stg} (μs)	t _f (μs)
70	10	7	10	-5	7	-7	0.5typ	10.0typ	1.1typ

I_C-V_{CE}特性 (代表例)

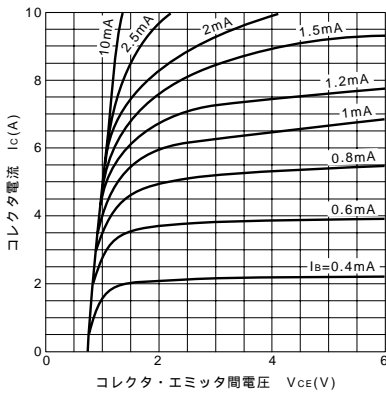

V_{CE(sat)}-I_B特性 (代表例)

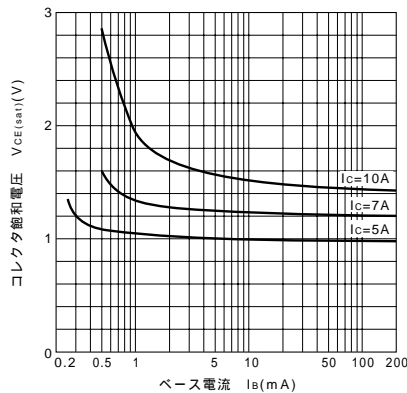

I_C-V_{BE}温度特性 (代表例)

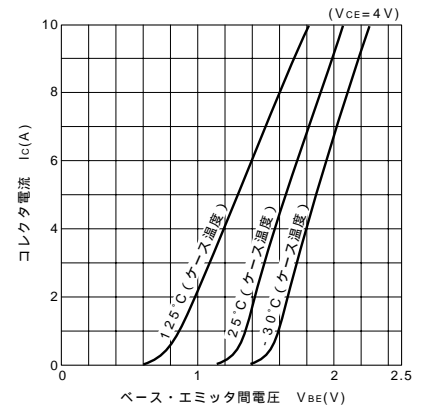

h_{FE}-I_C特性 (代表例)

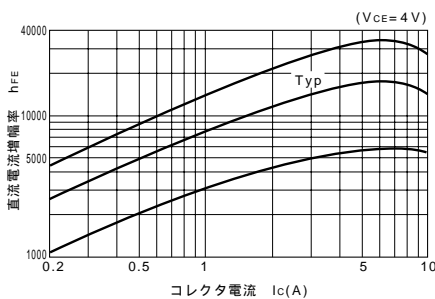

h_{FE}-I_C温度特性 (代表例)

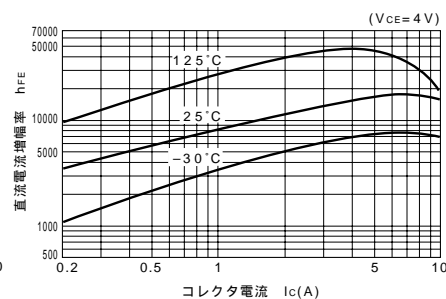

θ_{J-a-t}特性

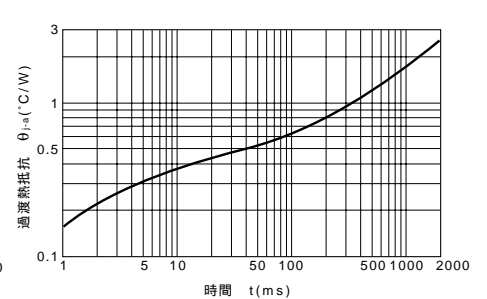

f_T-I_E特性 (代表例)

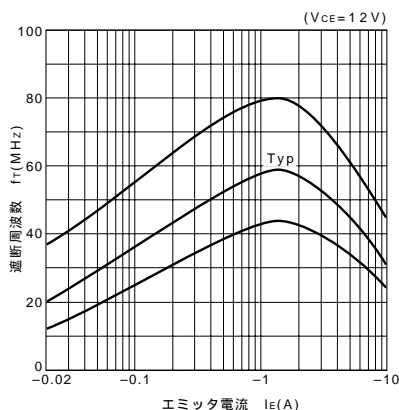

ASO曲線 (単発パルス)

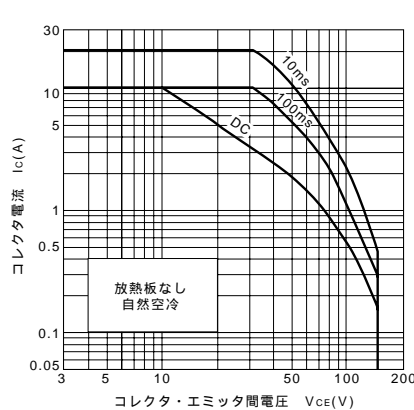

P_C-T_a定格

