

#### General Description

The C Series power supplies are configurable with combinations of insertable DC modules for various single, multiple, or parallel output.

#### Features and Benefits

- High reliability with low noise and low leakage current
- Medical and information equipment approval to UL60950-1, C-UL, EN60950 and EN60601-1 3rd
- Higher withstand voltage and lower leakage current
- OCP, OVP and OHP, remote sensing, control, and alarm (AC power fail, fan alarm, and low output)

#### Table of Contents

Test Circuit	1
Figures	3
Tables	7
Important Information	9

#### Sample Test Conditions

##### Input Voltage, $V_{IN}$

Min. (V)	Nom. (V)	Max. (V)
-	-	-

##### Load Current, $I_{LOAD}$ (Output Circuit: 3.3 V)

Min. (A)	Nom. (A)	Max. (A)
0	26	26

#### Sample Test Circuit Diagram

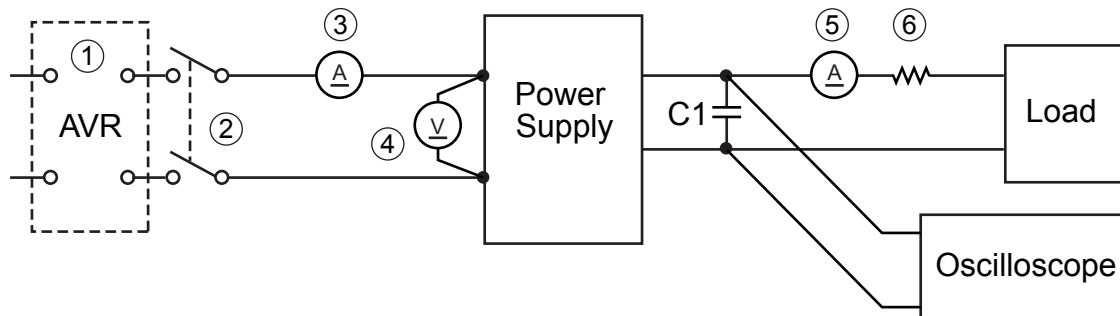

Key	Description	Remarks
-	Measuring instrument	Output voltage is measured with a digital multimeter
1	Automatic Voltage Regulator	-
2	Circuit breaker	-
3	Ammeter	-
4	Volt meter	-
5	Ammeter	-
6	Shunt resistor	-
C1	Load capacitor	Electrolytic capacitor: 47 $\mu$ F Film capacitor: 0.1 $\mu$ F

## List of Figures

---

<b>1. Efficiency</b>	<b>3</b>
<b>2. Output Voltage Accuracy</b>	<b>3</b>
<b>3. Warm-Up Drift</b>	<b>4</b>
<b>4. Ripple Voltage</b>	<b>4</b>
<b>5. Ripple Noise Voltage</b>	<b>5</b>
<b>6. Overcurrent Protection</b>	<b>5</b>
<b>7. Overvoltage Protection</b>	<b>6</b>

## List of Tables

---

<b>1. Input Characteristics</b>	<b>7</b>	<b>3. Protection Characteristics</b>	<b>7</b>
Efficiency		Overcurrent Protection	
<b>2. Output Characteristics</b>	<b>7</b>	Overvoltage Protection	
Output Setting Voltage		<b>4. Environment Tests</b>	<b>8</b>
Input/Output Voltage Change Fluctuation		Vibration (Non-Operating)	
Temperature Drift		Power-On at High Temperature	
Warm-Up Drift		Power-On at Low Temperature	
Total Regulation		Shock	
Static Load Regulation		<b>5. Other Characteristics</b>	<b>8</b>
Ripple Voltage		Withstand Voltage	
Ripple Noise Voltage		Leakage Current at Withstand Voltage	
Output Voltage Variable Range		Insulation Resistance	

## Figures

**Figure 1. Efficiency (By Load Current)**

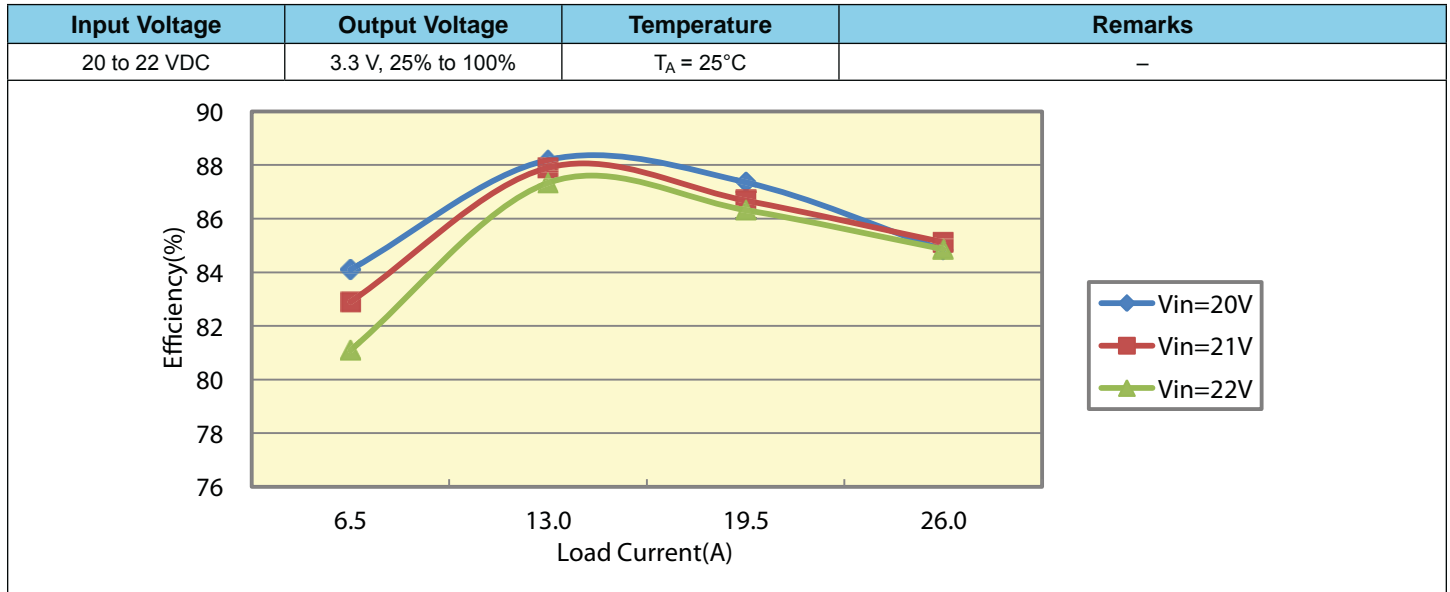

**Figure 2. Output Voltage Accuracy (By Load Current)**

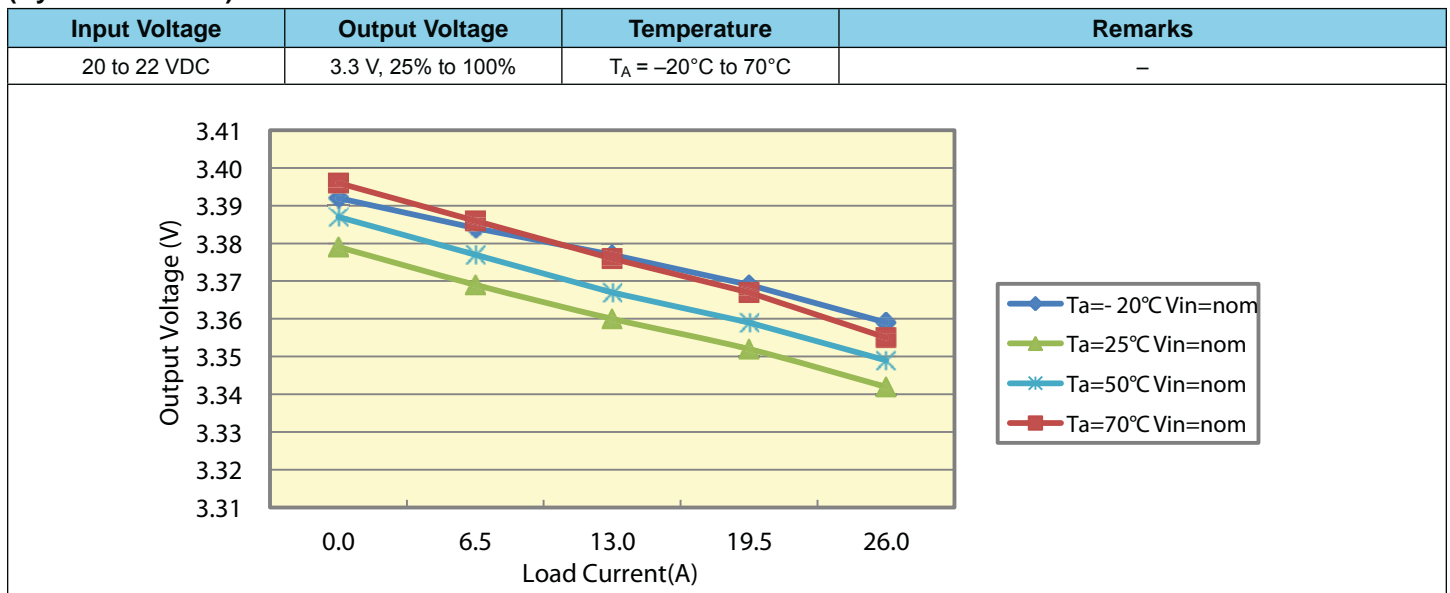

**Figure 3. Warm-Up Drift**

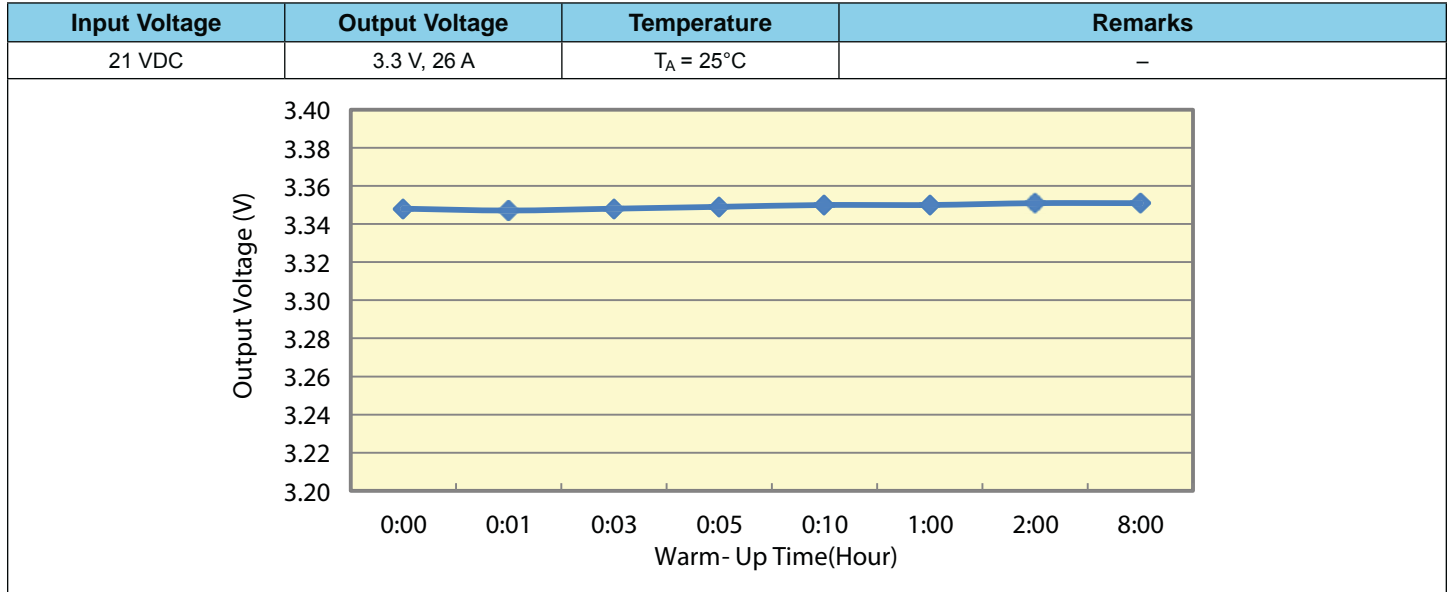

**Figure 4. Ripple Voltage (By Load Current)**

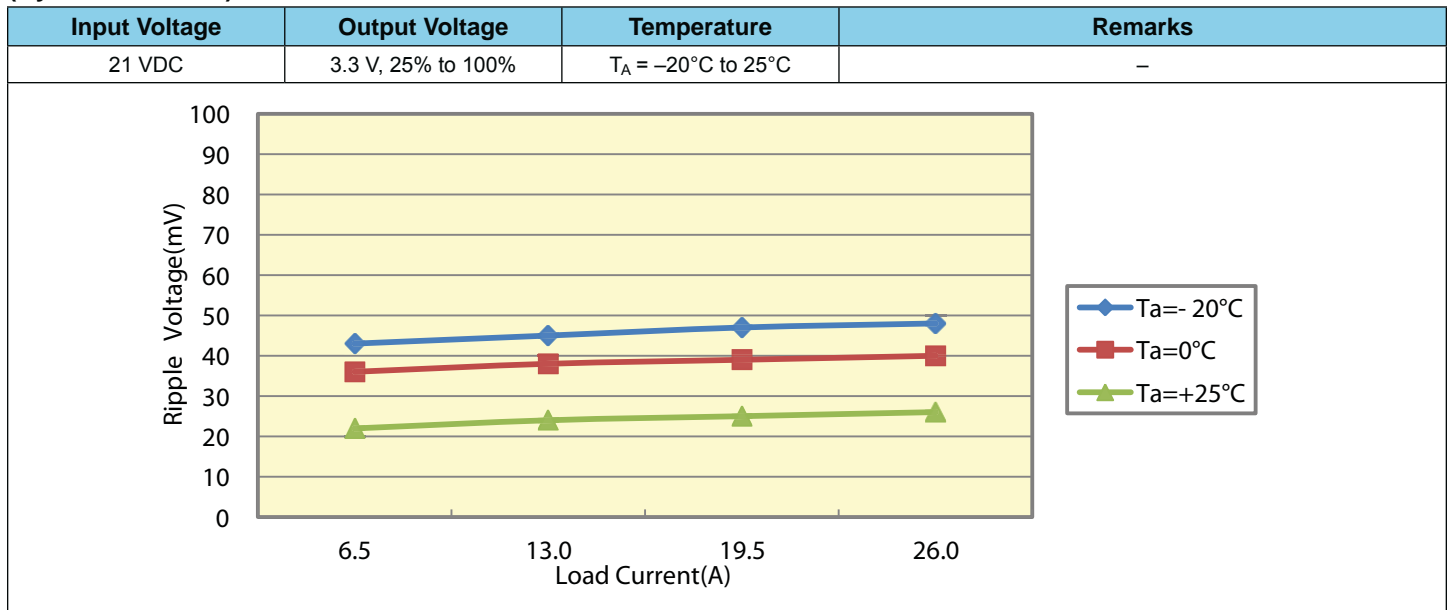

**Figure 5. Ripple Noise Voltage  
(By Load Current)**

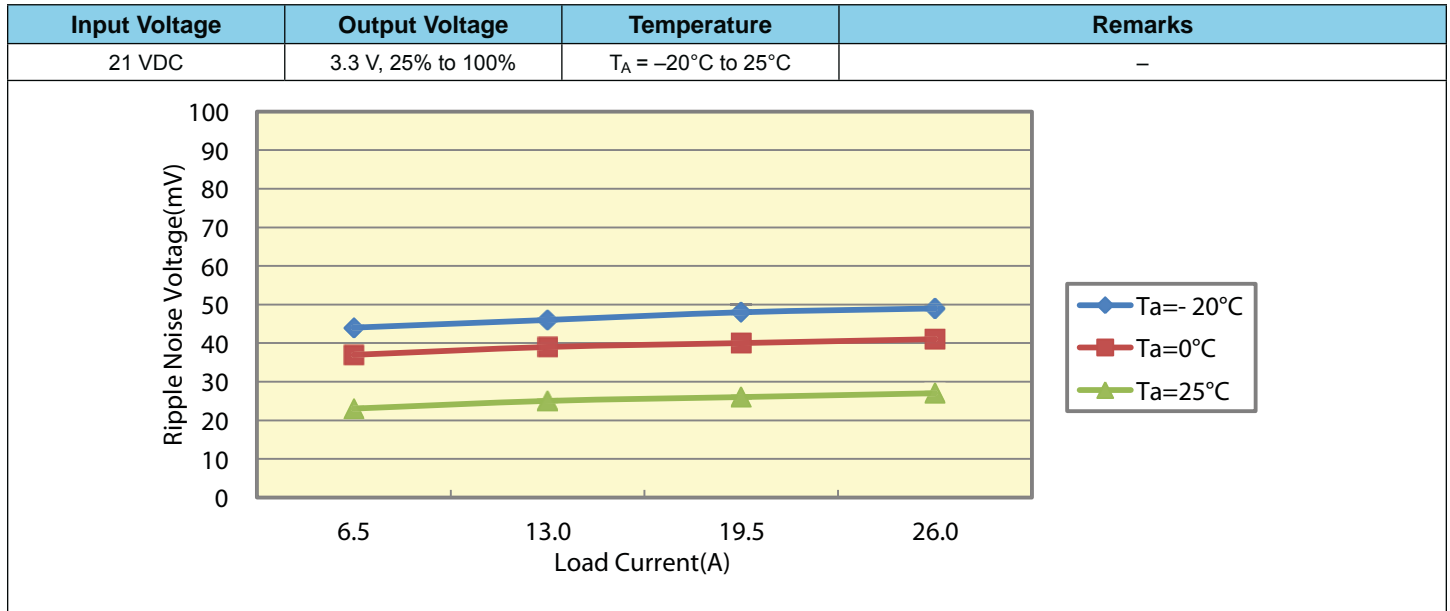

**Figure 6. Overcurrent Protection  
(By Load Current)**

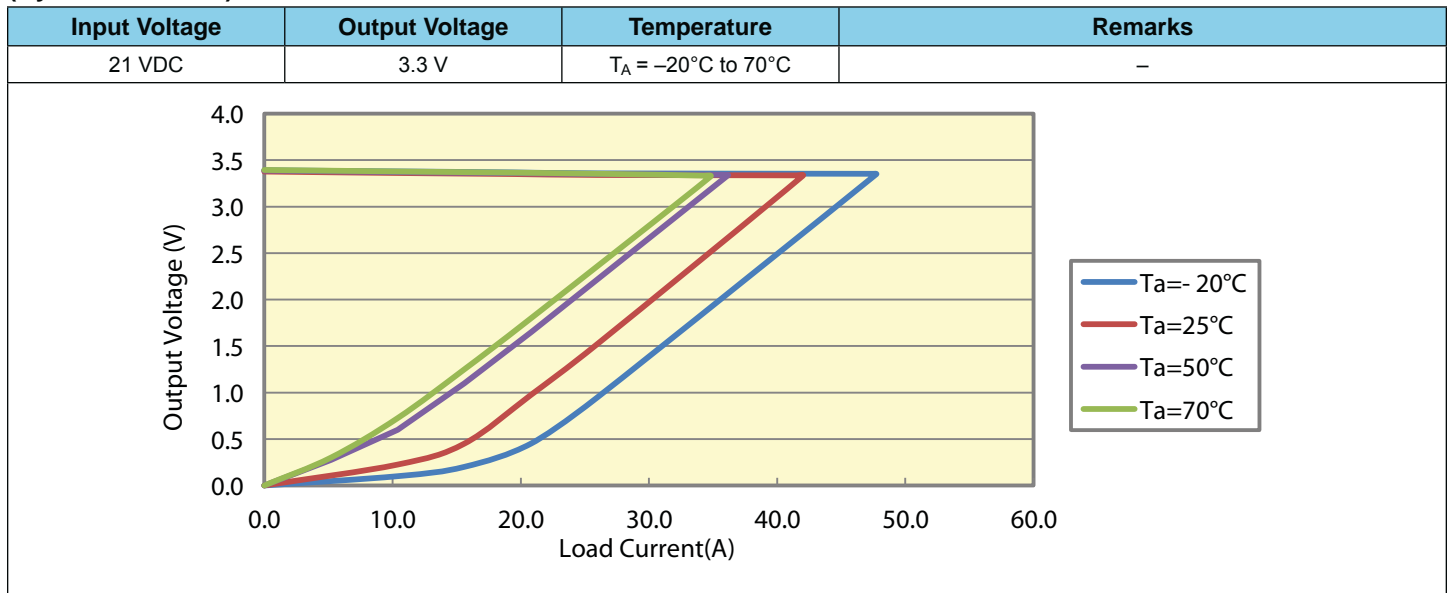

**Figure 7. Overvoltage Protection  
(By Temperature)**

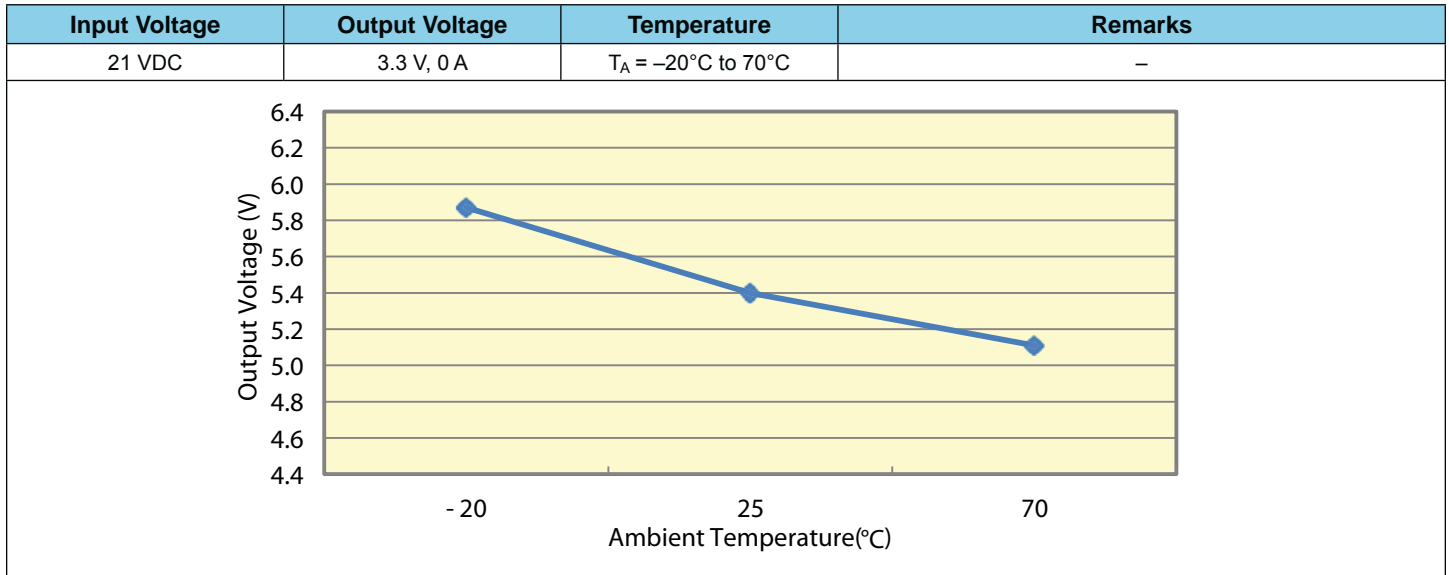

## Tables

**Table 1. Input Characteristics**  
(At  $T_A = 25^\circ\text{C}$ )

Test Item	Conditions		Test Results			Specification	Remarks
	$V_{IN}$	$I_{LOAD}$	$V_{IN} = 21\text{ V}$				
Efficiency	Nom	Nom	85.1%			86.0%	Figure 1

**Table 2. Output Characteristics**  
(At  $T_A = 25^\circ\text{C}$ )

Test Item	Conditions		Test Results			Specification	Remarks
	$V_{IN}$	$I_{LOAD}$	$V_{IN} = 3.3\text{ V}$				
Output Setting Voltage	Nom	Nom	3.342 V				–
Input/Output Voltage Change Fluctuation	Min	Min	3.342 V				Note 1, figure 2
	Max	Max	3.379 V				
Temperature Drift	Nom	Nom	0 mV to +17 mV				Note 1, figure 2
Warm-Up Drift	Nom	Nom	+4 mV				Note 1, figure 3
Total Regulation	–	–	3.342 to 3.40 V				Note 1
Static Load Regulation	–	–	$\pm 99\text{ mV}$				Note 2
Ripple Voltage	Nom	Nom	26 mV at $T_A = 25^\circ\text{C}$			180 mV	Note 3, figure 4
Ripple Noise Voltage	Nom	Nom	27 mV at $T_A = 25^\circ\text{C}$			180 mV	Note 4, figure 5
Output Voltage Variable Range	–	–				2.6 to 3.6 V	–

1. Total Regulation (output regulation) is the sum of: Input/Output Voltage Change Fluctuation, Temperature Drift, and Warm-Up Drift.

2. This shows the static load regulation against the output voltage value set within the Output Variable Voltage Range.

3. Used probe = Ripple Voltage 1:1.

4. Used probe = Ripple Noise Voltage 1:1.

**Table 3. Protection Characteristics**  
(At  $V_{IN} = +3.3\text{ V}$ )

Test Item	Conditions		Test Results			Specification	Remarks
	$V_{IN}$	$I_{LOAD}$	$T_A = -20^\circ\text{C}$	$T_A = 25^\circ\text{C}$	Overcurrent $T_A = 50^\circ\text{C}$ Overvoltage $T_A = 70^\circ\text{C}$		
Overcurrent Protection	Min	Max	47.7 A	42.0 A	36.2 A	$\geq 27.3\text{ A}$	Figure 6
Overvoltage Protection	Nom	Min	5.9 V	5.4 V	5.1 V	$\geq 3.8\text{ V}$	Figure 7

**Table 4. Environment Tests**  
(At  $T_A = 25^\circ\text{C}$ )

Test Item	Conditions		Test Results	Specification	Remarks
	$V_{IN}$	$I_{LOAD}$			
Vibration (Non-Operating)	–	–	Frequency = 10 to 55 Hz, Sweep Cycle = 3 minutes, Acceleration = 19.6 m/s <sup>2</sup> , Direction = x,y, and z axes at 60 minutes per axis	Normal operation	–
Power-On at High Temperature	Nom	Max	Power-off for 1 hour at 65°C, then power-on	Normal operation	–
Power-On at Low Temperature	Nom	Max	Power-off for 1 hour at –15°C, then power-on	Normal operation	–
Shock	–	–	Product is dropped from a height of 50 mm (98 m/s <sup>2</sup> ) onto a flat surface of wood (10 mm or thicker); the test is performed three times on each edge of the bottom side of the product	Normal operation	–

**Table 5. Other Characteristics**  
(At  $T_A = 25^\circ\text{C}$ )

Test Item	Conditions		Test Results			Specification	Remarks
	$V_{IN}$	$I_{LOAD}$	P–S	P–E	S–E		
Withstand Voltage	–	–	–	–	0.6 kV	S–E 500 V for 1 minute, 600 V for 1 second	–
Leakage Current at Withstand Voltage	–	–	–	–	0 mA	S–E ≤15 mA	–
Insulation Resistance	–	–	–	–	≥1000 MΩ	≥50 MΩ at 500 VDC Megger	–



## Important Information



- The products described in this document are built-in type DC stabilized power supplies with special structures and are designed for installation in equipment. Be sure to use the products only for installation in equipment.
- The products should be handled only by persons who have competent electrical knowledge.
- Be sure to read through all safety precaution and operation manuals before installation, operation, or maintenance and to use the products only for the intended use and in accordance with all applicable safety standards and regulations in the location of use.

---

Sanken reserves the right to make, from time to time, such departures from the detail specifications as may be required to permit improvements in the performance, reliability, or manufacturability of its products. Therefore, the user is cautioned to verify that the information in this publication is current before placing any order.

When using the products described herein, the applicability and suitability of such products for the intended purpose shall be reviewed at the users responsibility.

Although Sanken undertakes to enhance the quality and reliability of its products, the occurrence of failure and defect of semiconductor products at a certain rate is inevitable.

Users of Sanken products are requested to take, at their own risk, preventative measures including safety design of the equipment or systems against any possible injury, death, fires or damages to society due to device failure or malfunction.

Sanken products listed in this publication are designed and intended for use as components in general-purpose electronic equipment or apparatus (home appliances, office equipment, telecommunication equipment, measuring equipment, etc.). Their use in any application requiring radiation hardness assurance (e.g., aerospace equipment) is not supported.

When considering the use of Sanken products in applications where higher reliability is required (transportation equipment and its control systems or equipment, fire- or burglar-alarm systems, various safety devices, etc.), contact a company sales representative to discuss and obtain written confirmation of your specifications.

The use of Sanken products without the written consent of Sanken in applications where extremely high reliability is required (aerospace equipment, nuclear power-control stations, life-support systems, etc.) is strictly prohibited.

The information included herein is believed to be accurate and reliable. Application and operation examples described in this publication are given for reference only and Sanken assumes no responsibility for any infringement of industrial property rights, intellectual property rights, or any other rights of Sanken or any third party that may result from its use. The contents in this document must not be transcribed or copied without Sanken's written consent.