

SWF Series SWF100P-24 100 W, High Surge Tolerant, Low Noise Power Supply

General Description

The SWF series are compact, wide ranging power supplies, providing peak power capability that supports twice the rated output, making them ideal for motorized applications. They offer low noise and high efficiency by current resonant circuitry.

Features and Benefits

- Supports peak loading, two times the rated current (maximum of 10 seconds)
- World wide input (85 to 264 VAC)
- Provides high efficiency and low noise via current switching technology
- Acquired CE marking for Low Voltage Differential
- Conductive emission class B (VCCI class B, FCC class B, EN55022 class B)
- Safety standards: UL60950-1, C-UL (CSA60950-1), SEMKO (EN60950-1)
- Optional remote on/off control, and L type chassis, cover

Sample Test Conditions

Input Voltage, V_{IN}

Min. (V)	Nom. (V)		Max. (V)
85	100	240	264

Load Current, I_{LOAD}

Output Voltage (V)	Min. (A)	Nom. (A)	Max. (A)
24	0	4.2	8.4

Model Number Key Table

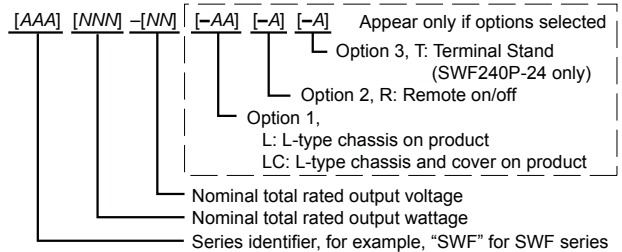

Sample Test Circuit Diagram

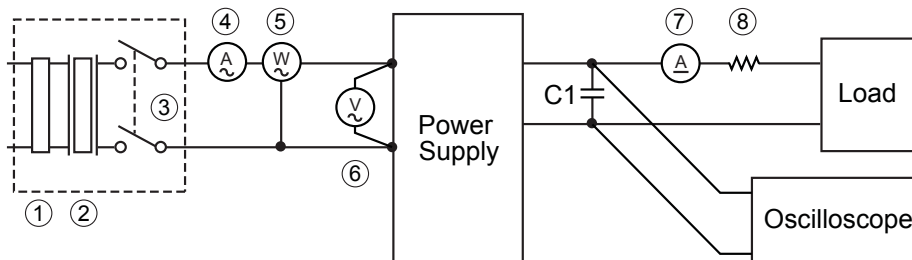

Key	Description	Remarks
-	Measuring instrument	Output voltage is measured with a digital multimeter
1	Variable autotransformer	-
2	Isolation transformer	-
3	Circuit breaker	-
4, 7	Ammeter	-
5	Watt meter	-
6	Volt meter	-
8	Shunt resistor	-
C1	24 V Load capacitor	Electrolytic capacitor: 100 μ F Film capacitor: 0.1 μ F

List of Tables

1. Input Characteristics	3	3. Protection Characteristics	11
Input Current		Overcurrent Protection	
Input Power		Overvoltage Protection	
Power Factor		Reset Time	
Efficiency		4. Environment Tests	14
Inrush Current		Vibration (Non-Operating)	
Leakage Current		Power-On at High Temperature	
Minimum Input Voltage for Voltage Output		Power-On at Low Temperature	
Hold-Up Time		Shock	
2. Output Characteristics	7	5. Noise Tolerance Characteristics	15
Output Setting Voltage		AC Line Noise	
Input/Output Voltage Change Fluctuation		Lightning Surge	
Temperature Drift		Electrostatic Discharge	
Warm-Up Drift		6. Other Characteristics	16
Total Regulation		Withstand Voltage	
Ripple Voltage		Leakage Current at Withstand Voltage	
Ripple Noise Voltage		Insulation Resistance	
Output Voltage Variable Range		7. Output under Dynamic Load	16
		Output Voltage at $T_A = -10^\circ\text{C}$	
		Output Voltage at $T_A = 60^\circ\text{C}$	

List of Figures

1. Input Current	3	11. Ripple Noise Voltage	9
2. Power Factor	4	12. Output Voltage Rising	9
3. Efficiency	4	13. Output Voltage Falling	10
4. Inrush Current	5	14. Overcurrent Protection	11
5. Inrush Current Operation	5	15. Overvoltage Protection	12
6. Leakage Current	6	16. Overvoltage Protection Operation	12
7. Hold-Up Time	6	17. Start-Up Time	13
8. Output Voltage Accuracy	7	18. Conduction Noise 100 V	15
9. Warm-Up Drift	8	19. Conduction Noise 230 V	15
10. Ripple Voltage	8	20. Dynamic Load	16

Table 1. Input Characteristics
(At $T_A = 25^\circ\text{C}$)

Test Item	Conditions		Test Results			Specification	Remarks
	V_{IN}	I_{LOAD}	$V_{IN} = 100\text{ V}$	$V_{IN} = 240\text{ V}$			
Input Current	Nom	Nom	1.17 A	0.49 A	–	1.4 A/0.6 A	Figure 1
Input Power	Nom	Nom	116.81 W	112.68 W	–	–	–
Power Factor	Nom	Nom	0.996	0.949	–	≥ 0.9	Figure 2
Efficiency	Nom	Nom	86.19%	89.35%	–	86% (typ) / 89% (typ)	Figure 3
Inrush Current	Nom	Nom	15.6 A	22.2 A	–	15 A/ 30 A	Figure 4
Leakage Current	Nom	Nom	0.058 mA at 60 Hz	0.136 mA at 60 Hz	$R = 1.5\text{ k}\Omega, C = 0.15\text{ }\mu\text{F}$	0.75 mA	Figure 5
Minimum Input Voltage for Voltage Output	–	Min	–	–	On = 76 V, Off = 12 V	–	–
	–	Nom	–	–	On = 76 V, Off = 38 V	–	–
Hold-Up Time	–	Nom	–	–	40 ms at $T_A = 25^\circ\text{C}$	20 ms	Figure 11

Figure 1. Input Current
(By Load Current)

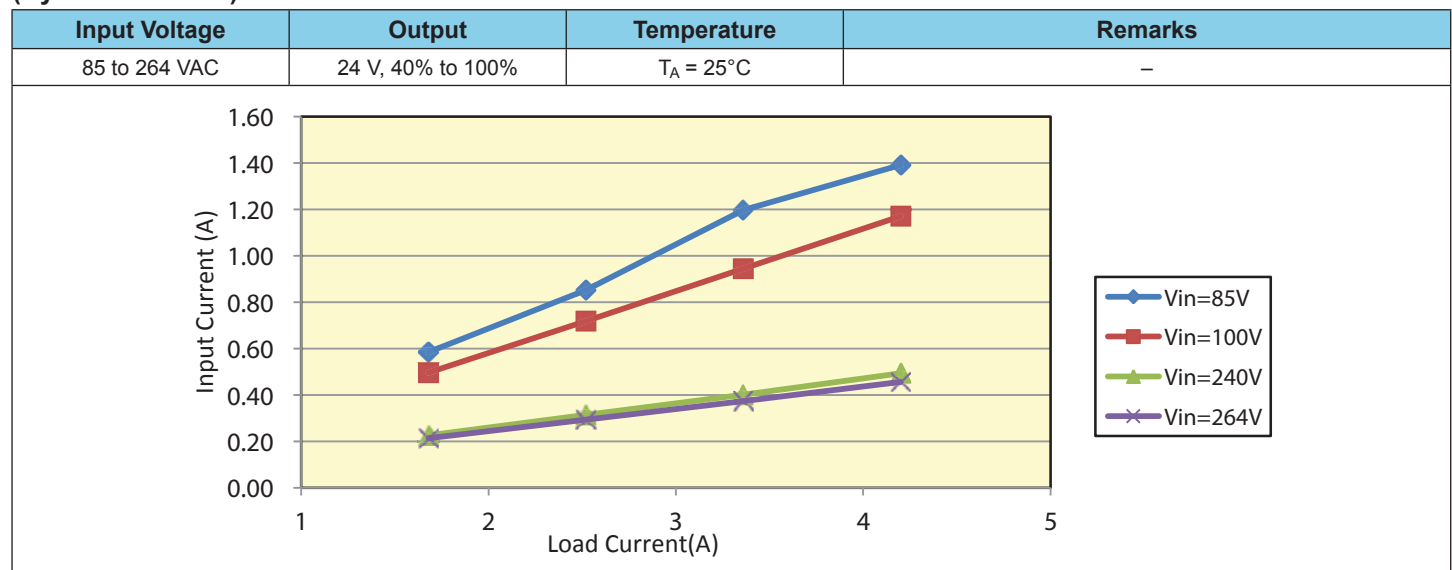

**Figure 2. Power Factor
(By Load Current)**

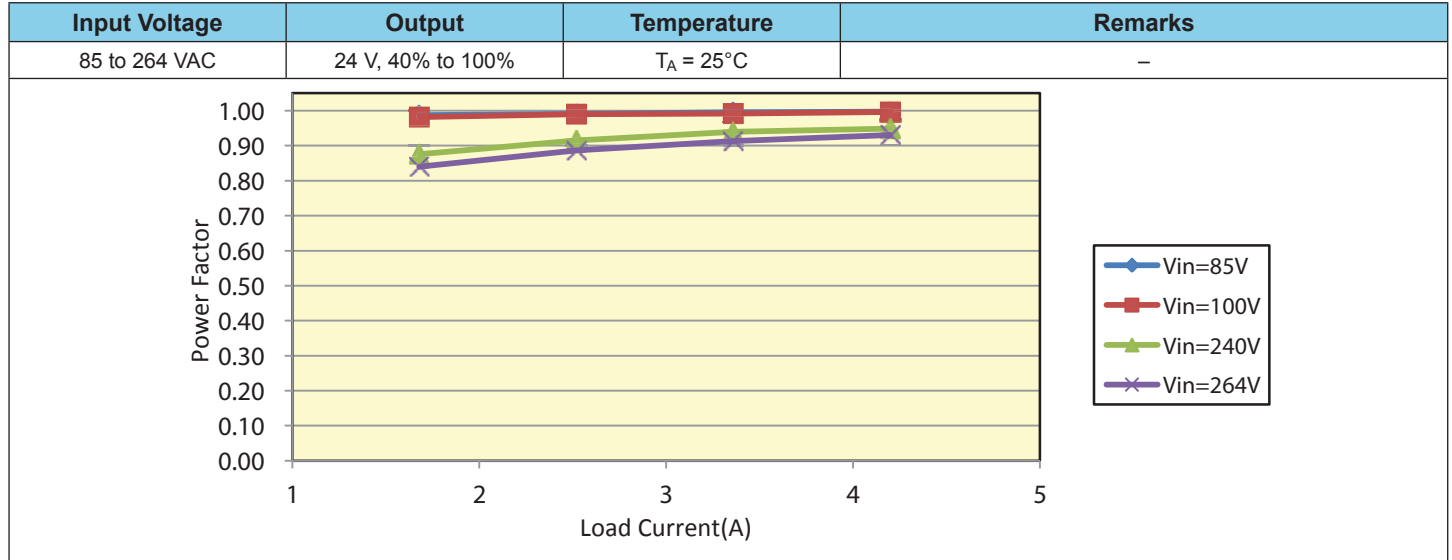

**Figure 3. Efficiency
(By Load Current)**

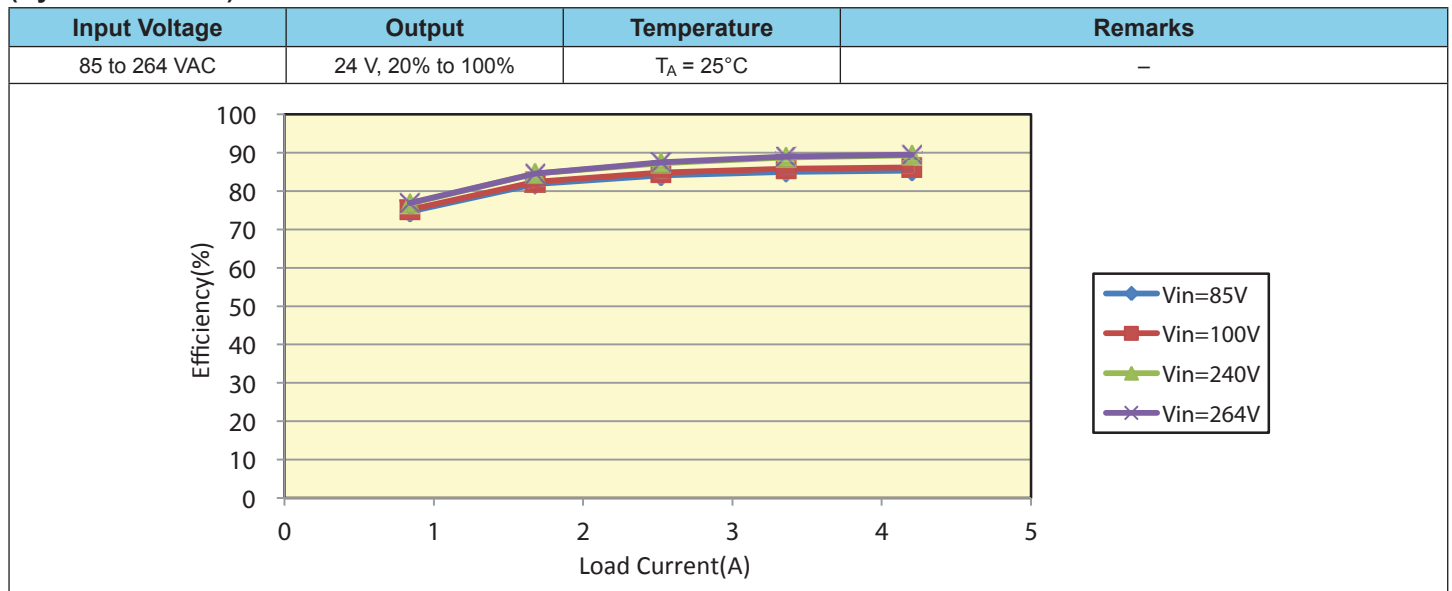

**Figure 4. Inrush Current
(By Input Voltage)**

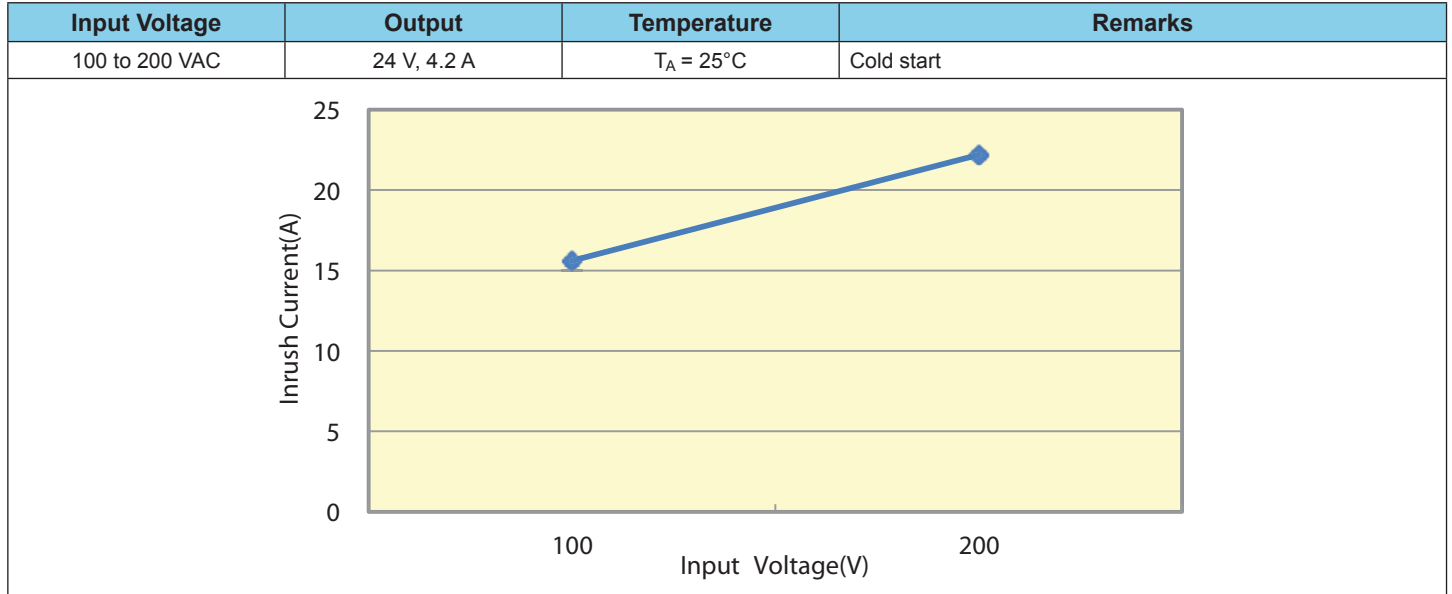

Figure 5. Inrush Current Operation

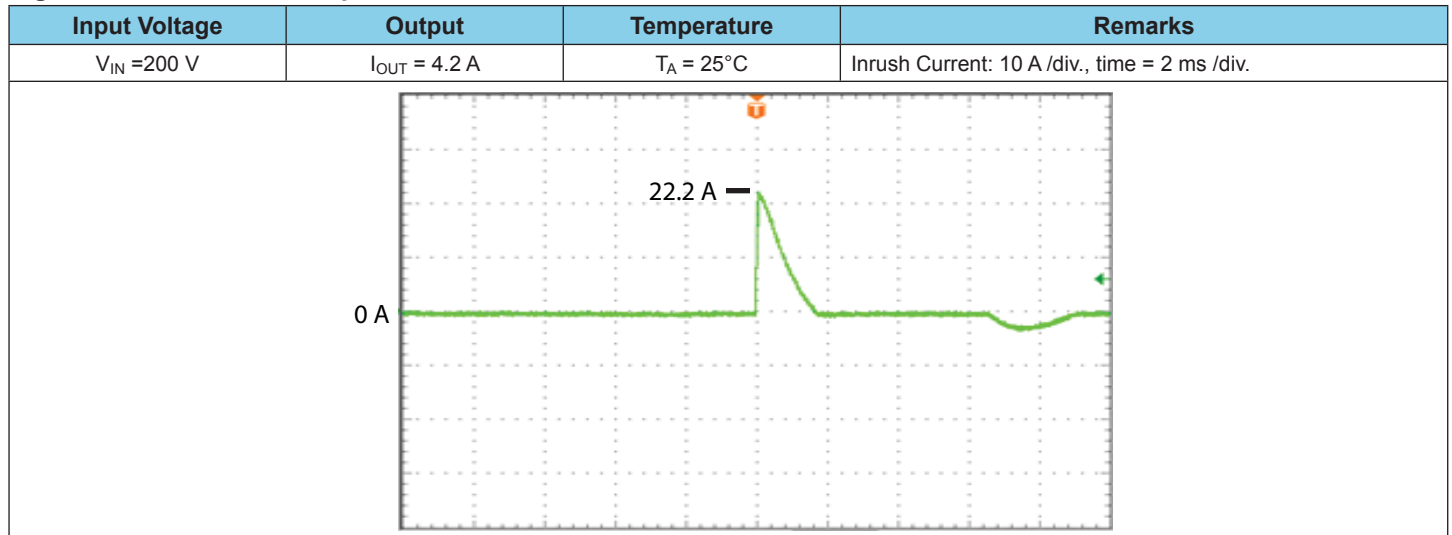

Figure 6. Leakage Current (By Load Current)

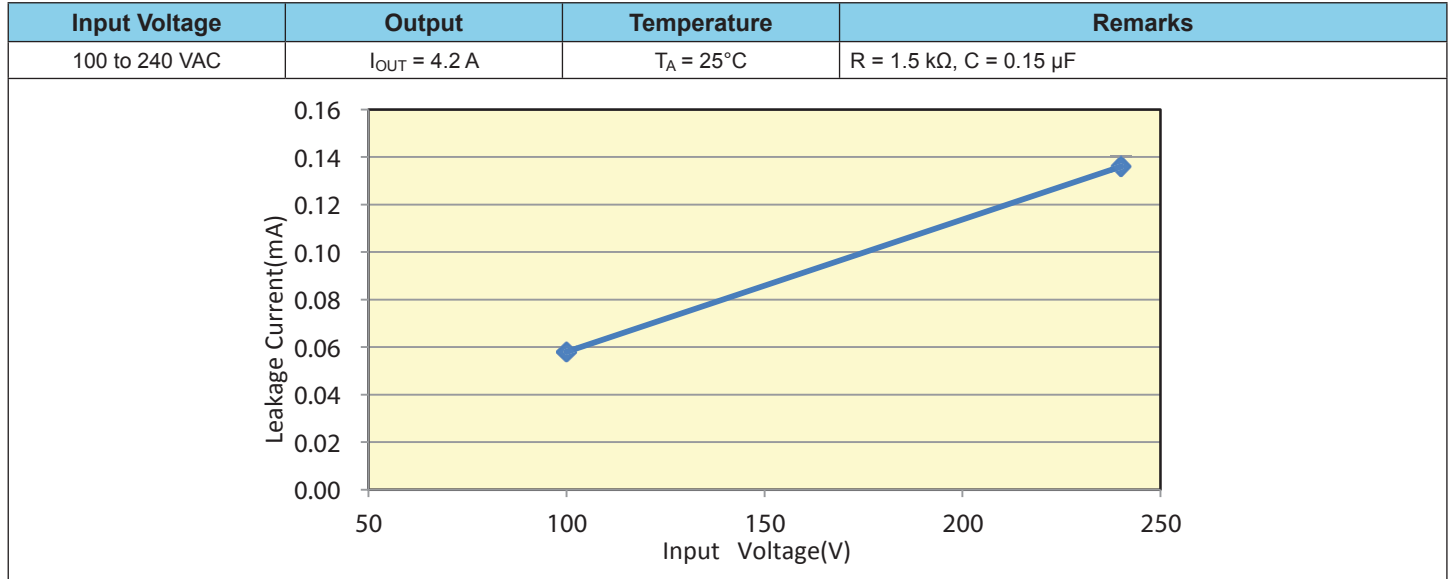

Figure 7. Hold-Up Time (By Load Current)

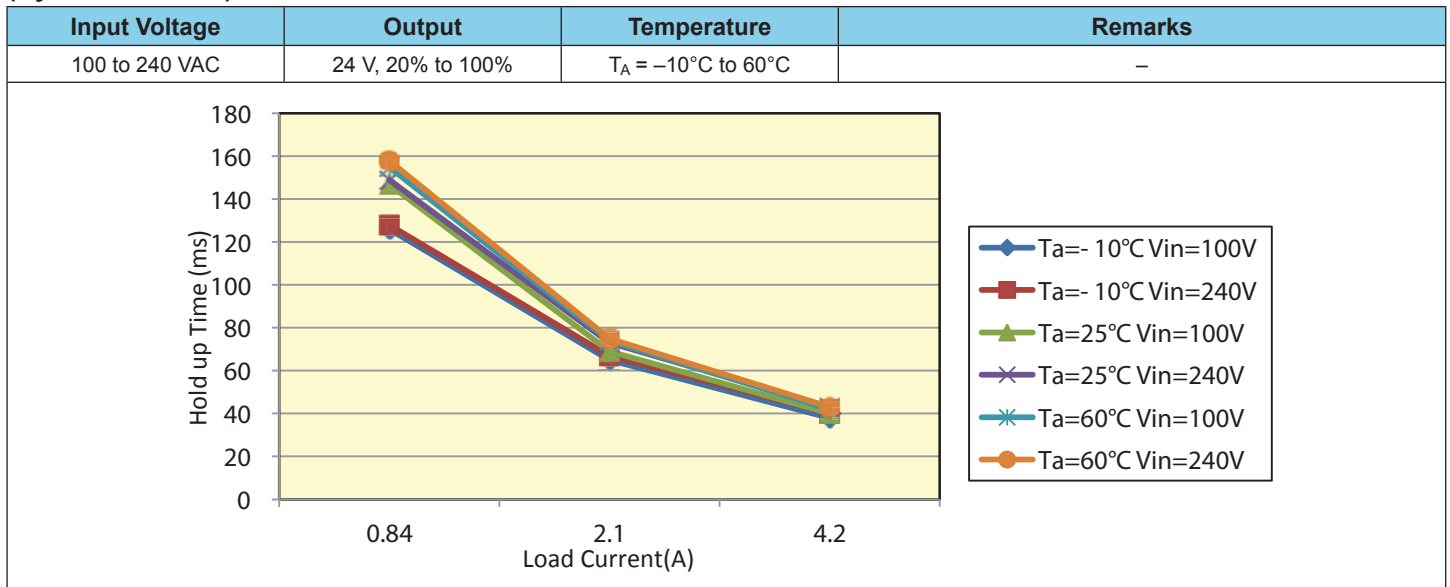

Table 2. Output Characteristics
(At $T_A = 25^\circ\text{C}$)

Test Item	Conditions		Test Results			Specification	Remarks
	V_{IN}	I_{LOAD}	24 V				
Output Setting Voltage	Nom	Nom	–			–	–
Input/Output Voltage Change Fluctuation	Min	Min	23.92 V			–	Note 1, Figure 8
	Max	Max	24.11 V			–	
Temperature Drift	Nom	Nom	–107 mV and +0 mV			–	Note 1, Figure 8
Warm-Up Drift	Nom	Nom	–7 mV			–	Note 1, Figure 9
Total Regulation	–	–	23.81 V			23.38 V	Note 1
	–	–	24.11 V			24.72 V	
Ripple Voltage	Nom	Nom	120 mV at $T_A = 25^\circ\text{C}$			160 mV at $T_A = -10^\circ\text{C}$ to 0°C 120 mV at $T_A = 0^\circ\text{C}$ to 60°C	Note 2, Figure 10
Ripple Noise Voltage	Nom	Nom	160 mV at $T_A = 25^\circ\text{C}$			180 mV at $T_A = -10^\circ\text{C}$ to 0°C 150 mV at $T_A = 0^\circ\text{C}$ to 60°C	Note 3, Figure 11
Output Voltage Variable Range	Min	Min	20.53 V			21.6 V	–
	Max	Max	27.33 V			26.4 V	–

1. Total Regulation (output regulation) is the sum of: Input/Output Voltage Change Fluctuation, Temperature Drift, and Warm-Up Drift.
2. Used probe = Ripple Voltage 1:1.
3. Used probe = Ripple Noise Voltage 1:1.

Figure 8. Output Voltage Accuracy
(By Load Current)

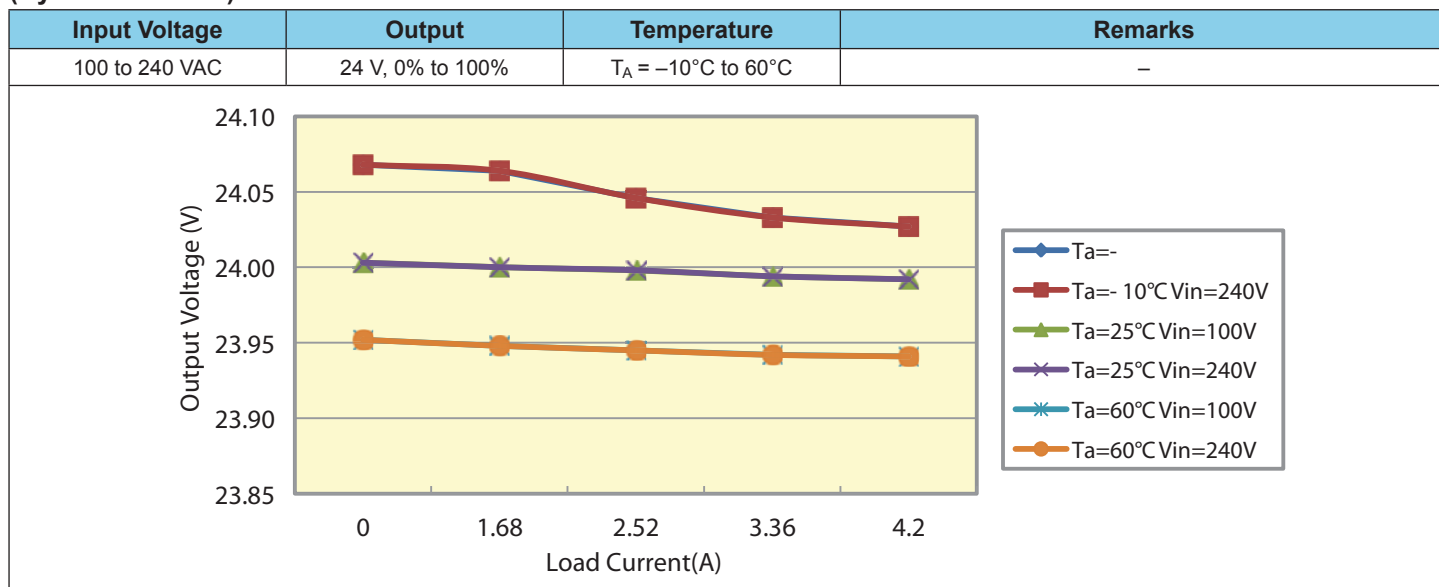

Figure 9. Warm-Up Drift

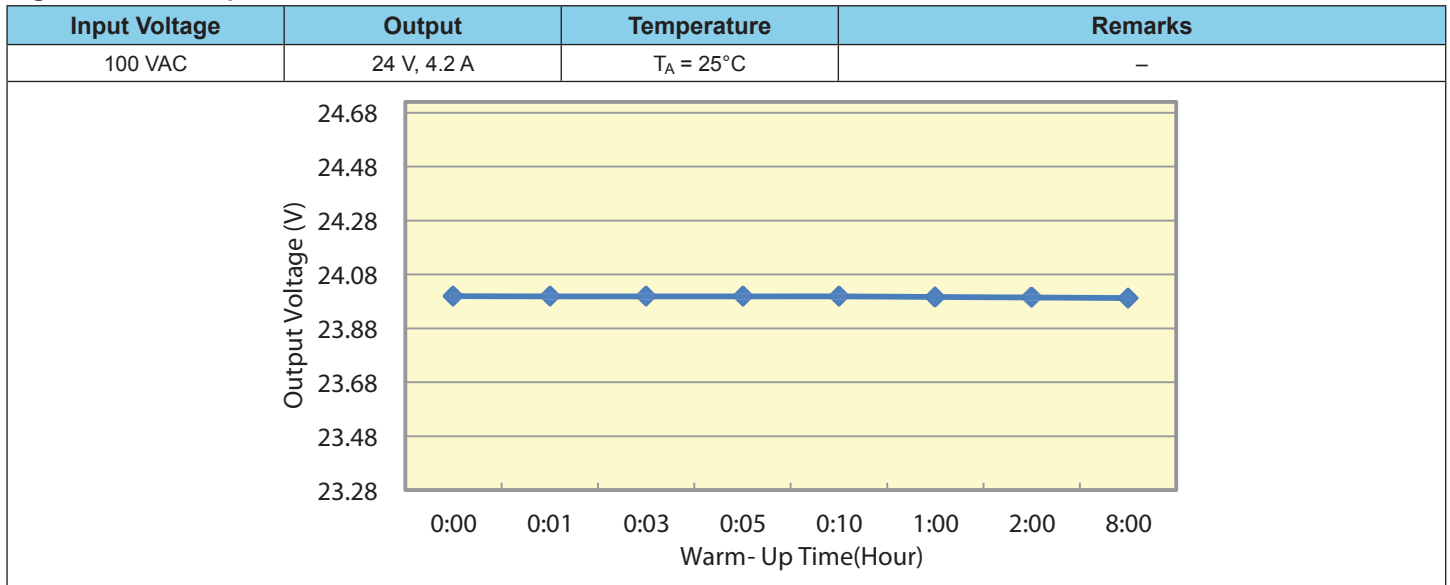
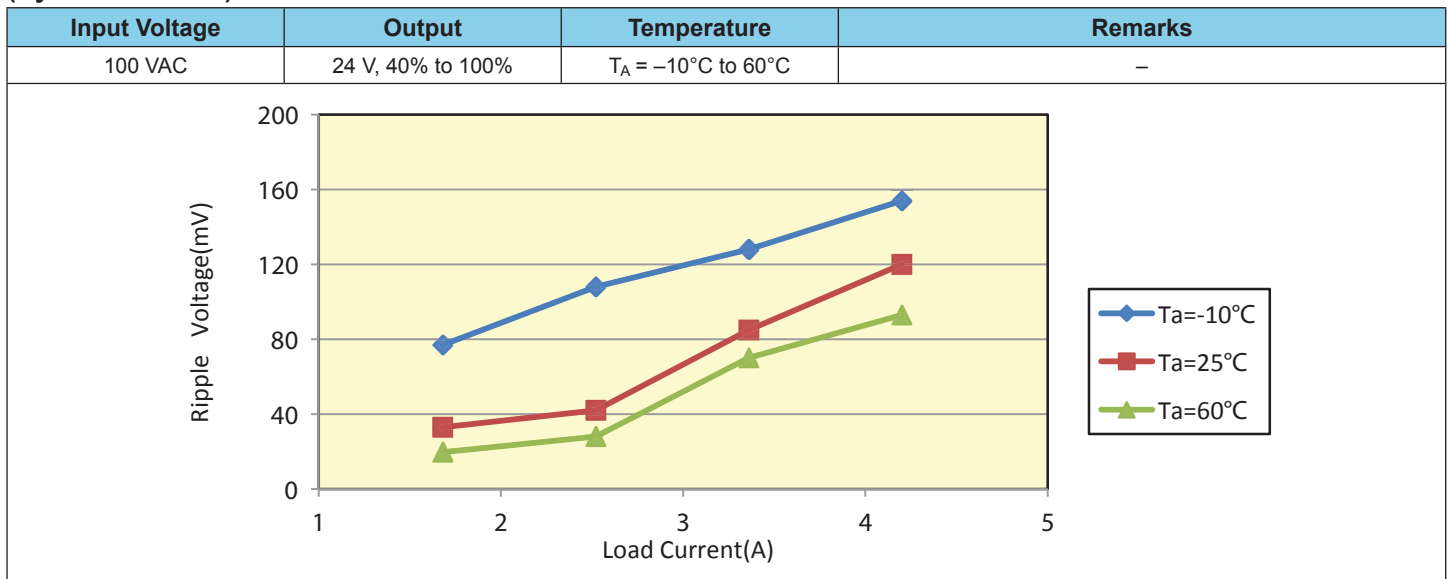

Figure 10. Ripple Voltage (By Load Current)



**Figure 11. Ripple Noise Voltage
(By Load Current)**

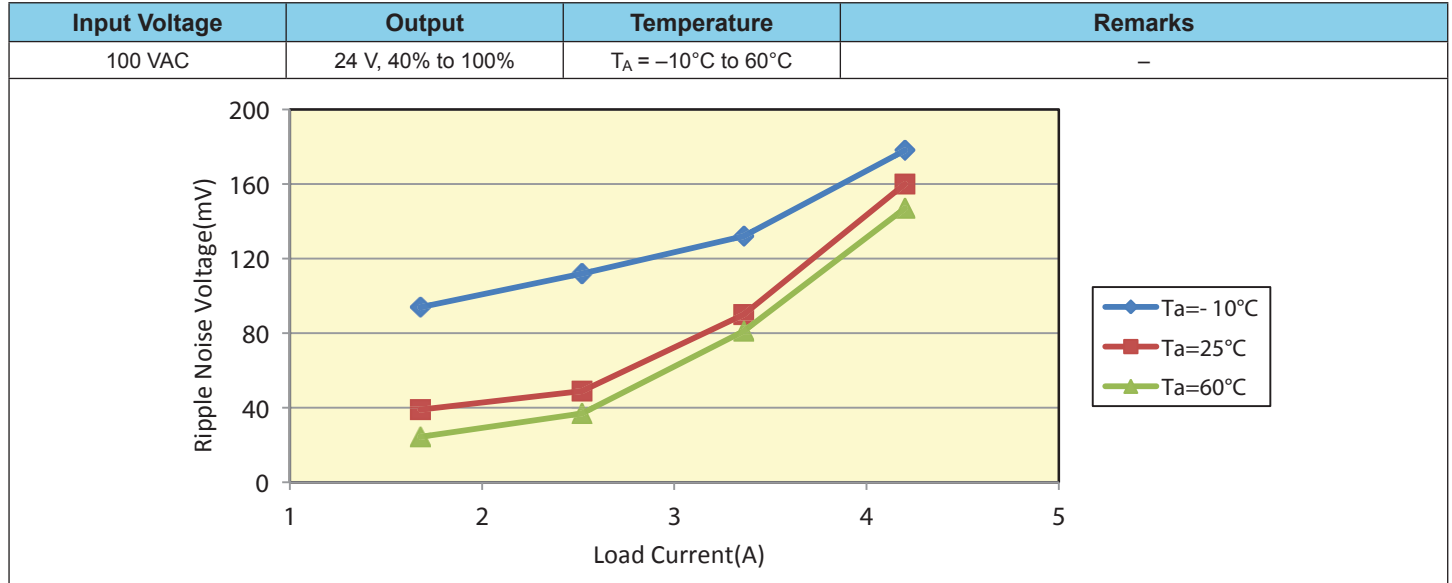

Figure 12. Output Voltage Rising

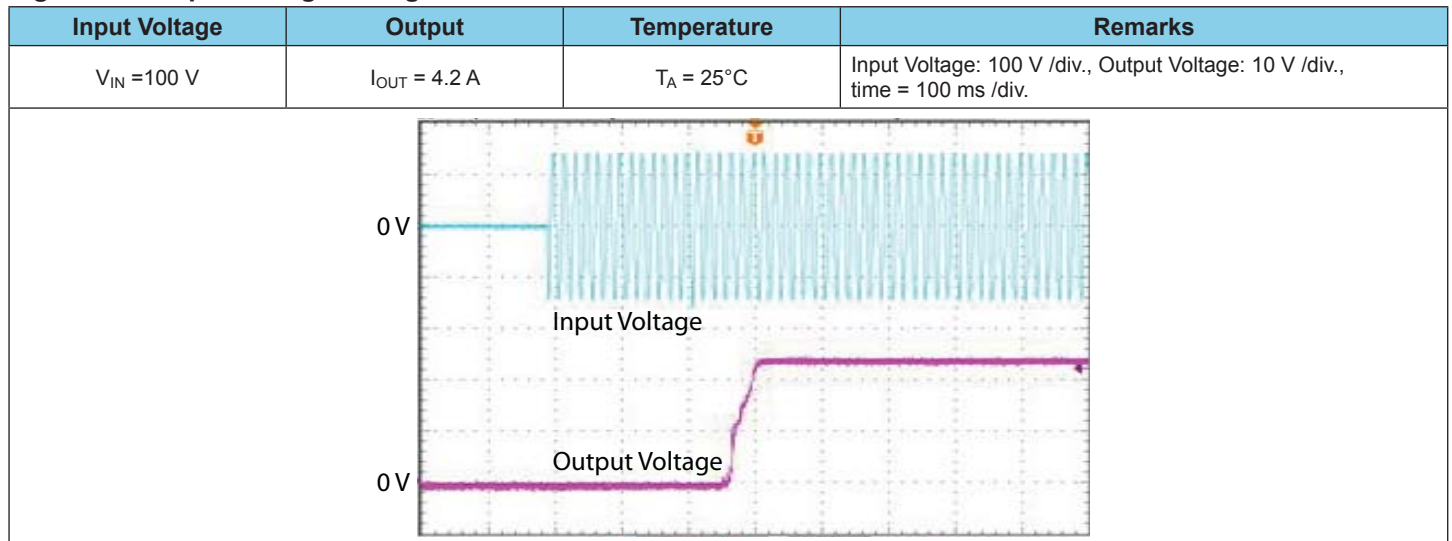

Figure 13. Output Voltage Falling

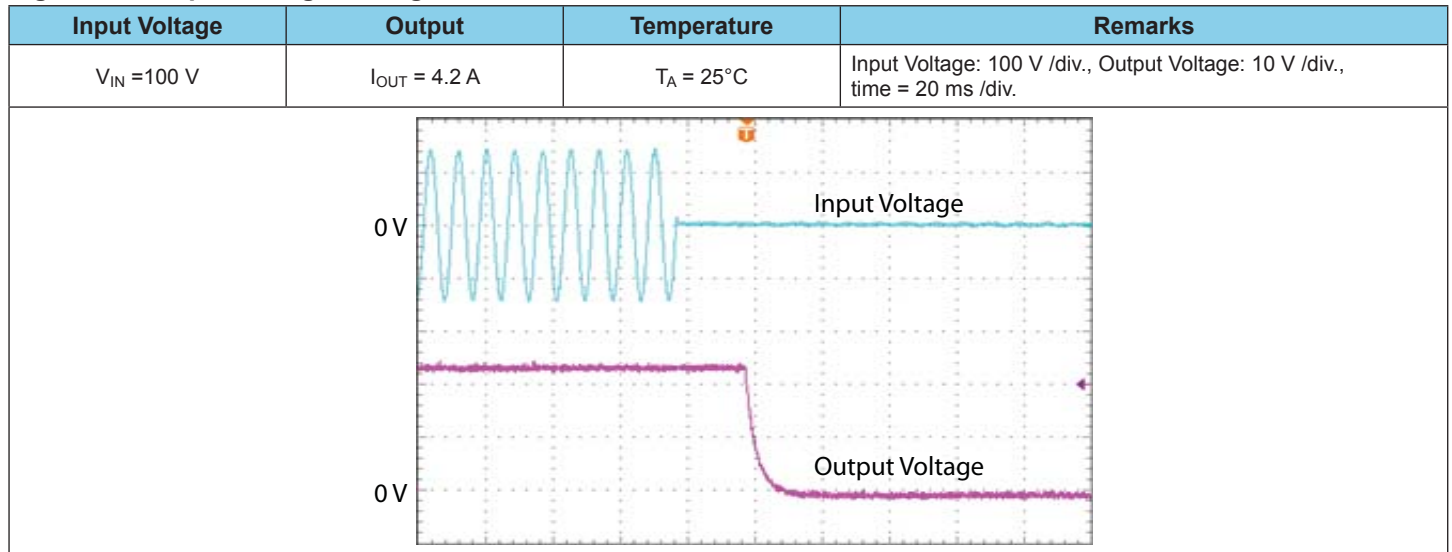

Table 3. Protection Characteristics

Test Item	Conditions		Test Results			Specifi- cation	Remarks
	V _{IN}	I _{LOAD}	T _A = -10°C	T _A = 25°C	T _A = 60°C		
Overcurrent Protection	Min	Max	8.90 A	9.28 A	9.49 A	≥ 8.48 A	Figure 14
Overvoltage Protection	Nom	Min	35.0 V	35.4 V	35.8 V	≥ 27.6 V	Figure 15
Reset Time	Max	Min	2.4 s at T _A = 25°C			-	-

**Figure 14. Overcurrent Protection
(By Load Current)**

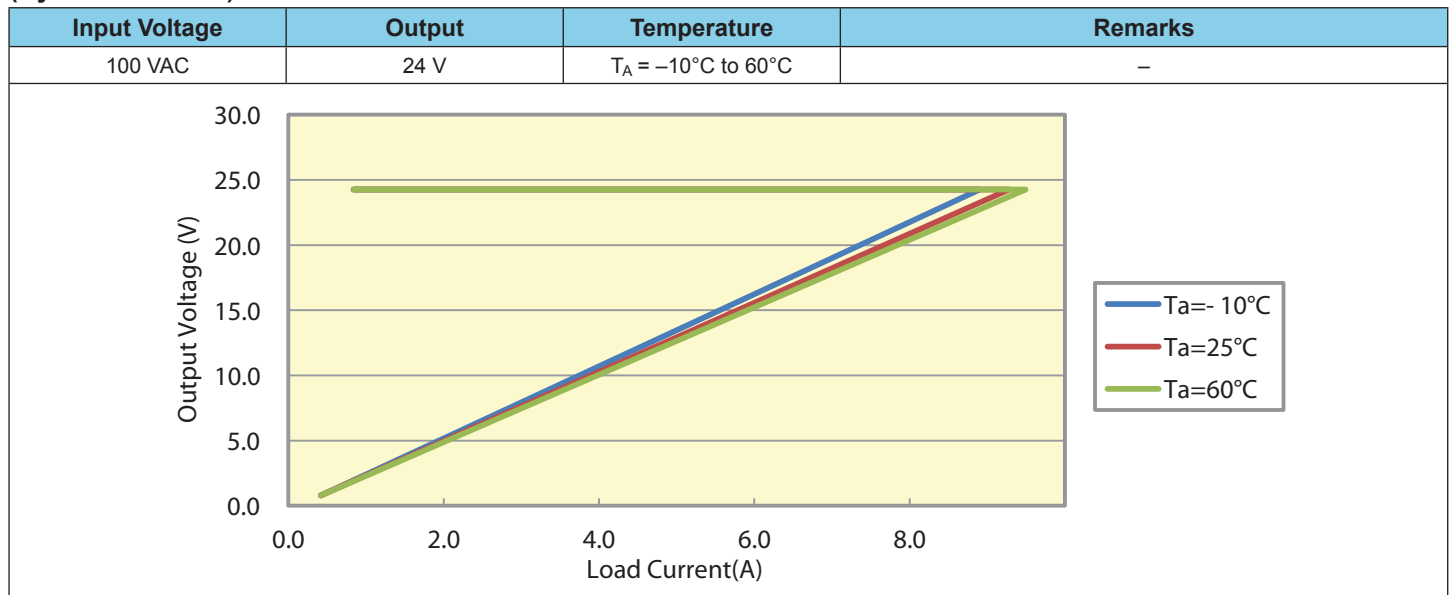

Figure 15. Overvoltage Protection (By Temperature)

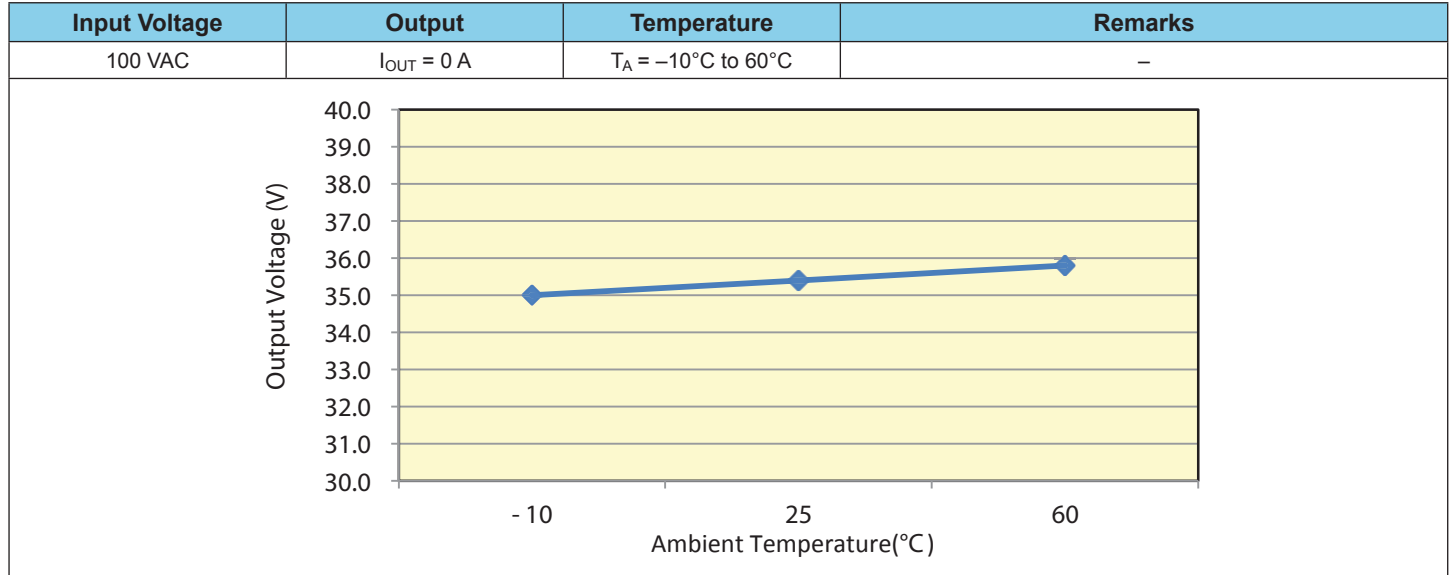
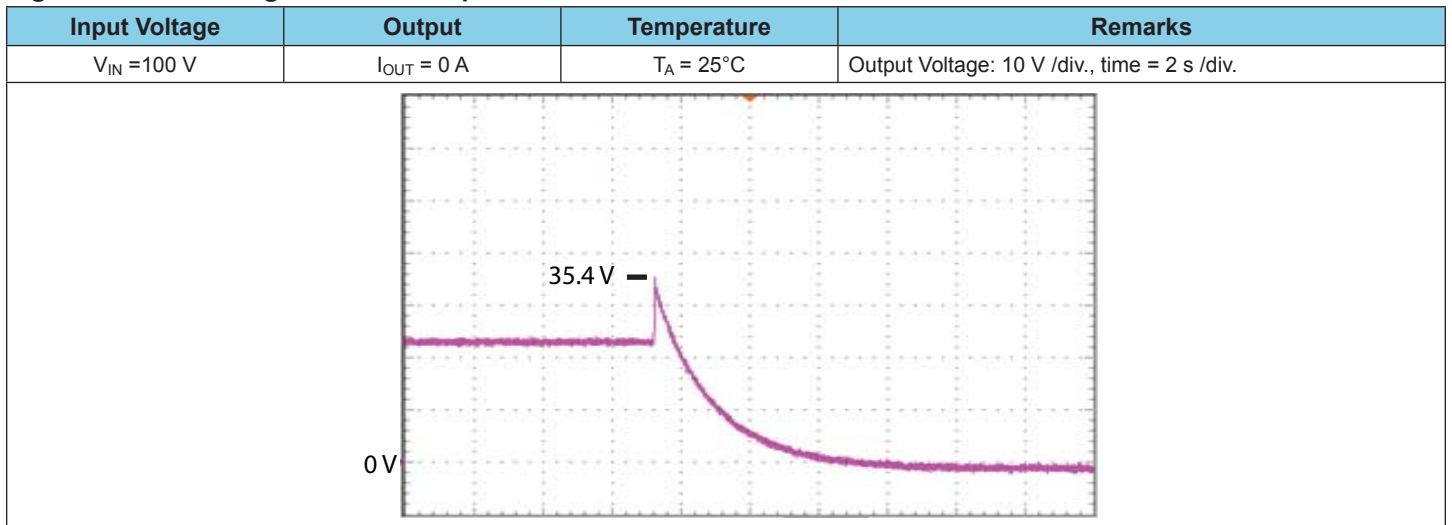

Figure 16. Overvoltage Protection Operation



**Figure 17. Start-Up Time
(By Input Voltage)**

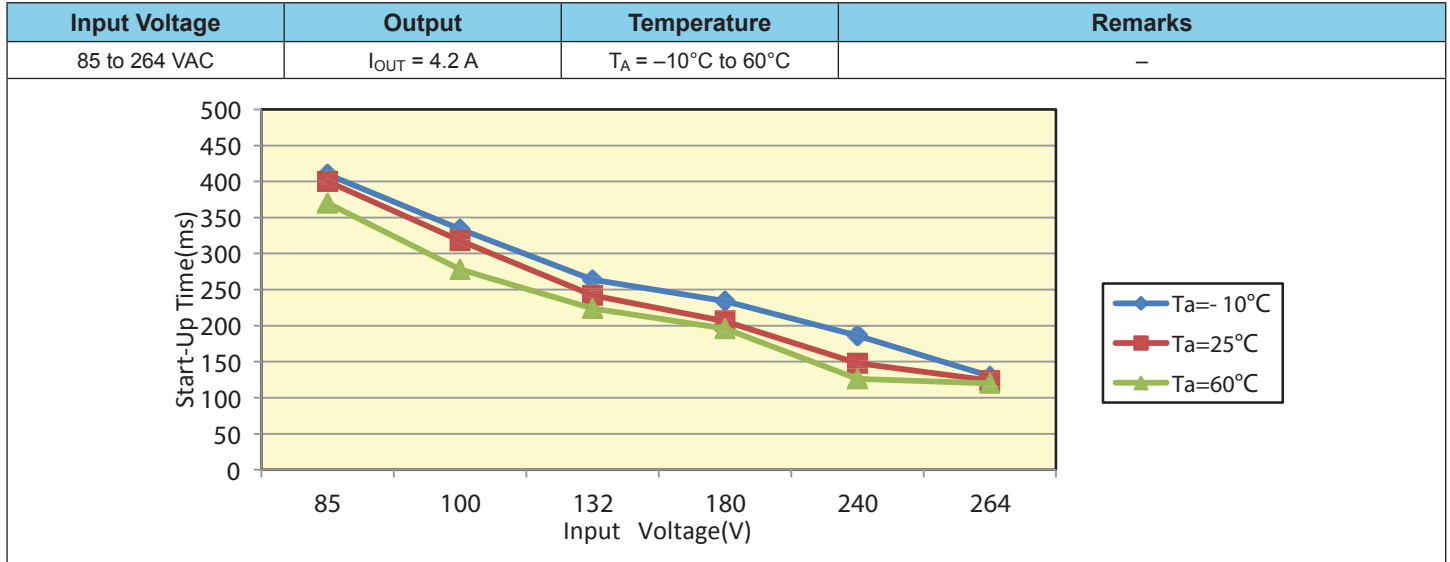

Table 4. Environment Tests
(At $T_A = 25^\circ\text{C}$)

Test Item	Conditions		Test Results	Specifi- cation	Remarks
	V _{IN}	I _{LOAD}			
Vibration (Non-Operating)	–	–	Frequency = 10 to 55 Hz, Sweep Cycle = 3 minutes, Acceleration = 19.6 m/s ² , Direction = x,y, and z axes at 60 minutes per axis	Normal operation	–
Power-On at High Temperature	Nom	Max	Power-off for 1 hour at 65°C, then power-on	Normal operation	–
Power-On at Low Temperature	Nom	Max	Power-off for 1 hour at –15°C, then power-on	Normal operation	–
Shock	–	–	Product is dropped from a height of 50 mm (98 m/s ²) onto a flat surface of wood (10 mm or thicker); the test is performed three times on each edge of the bottom side of the product	Normal operation	–

Table 5. Noise Tolerance Characteristics
(At $T_A = 25^\circ\text{C}$)

Test Item	Conditions		Test Results	Specifi- cation	Remarks
	V_{IN}	I_{LOAD}			
AC Line Noise (50 to 1000 ns)	Min to Max	Min to Max	Line to Line ± 2.4 kV OK	± 2 kV	–
	Min to Max	Min to Max	Line to Frame Ground ± 2.4 kV OK	± 2 kV	–
	Min to Max	Min to Max	Neutral to Frame Ground ± 2.4 kV OK	± 2 kV	
Lightning Surge ($1.2 \times 50 \mu\text{s}$)	Nom	Nom	Line to Neutral ± 2.4 kV OK	± 2.0 kV, 3 times	–
	Nom	Nom	Line to Frame Ground ± 2.4 kV OK	± 2.0 kV, 3 times	
	Nom	Nom	Neutral to Frame Ground ± 2.4 kV OK	± 2.0 kV, 3 times	
Electrostatic Discharge	Min to Max	Min to Max	Contact discharge ± 8.4 kV OK at $R = 330 \Omega$, $C = 150 \text{ pF}$	6 kV	–
	Min to Max	Min to Max	Aerial discharge ± 11.2 kV OK at $R = 330 \Omega$, $C = 150 \text{ pF}$	8 kV	

Figure 18. Conduction Noise 100 V

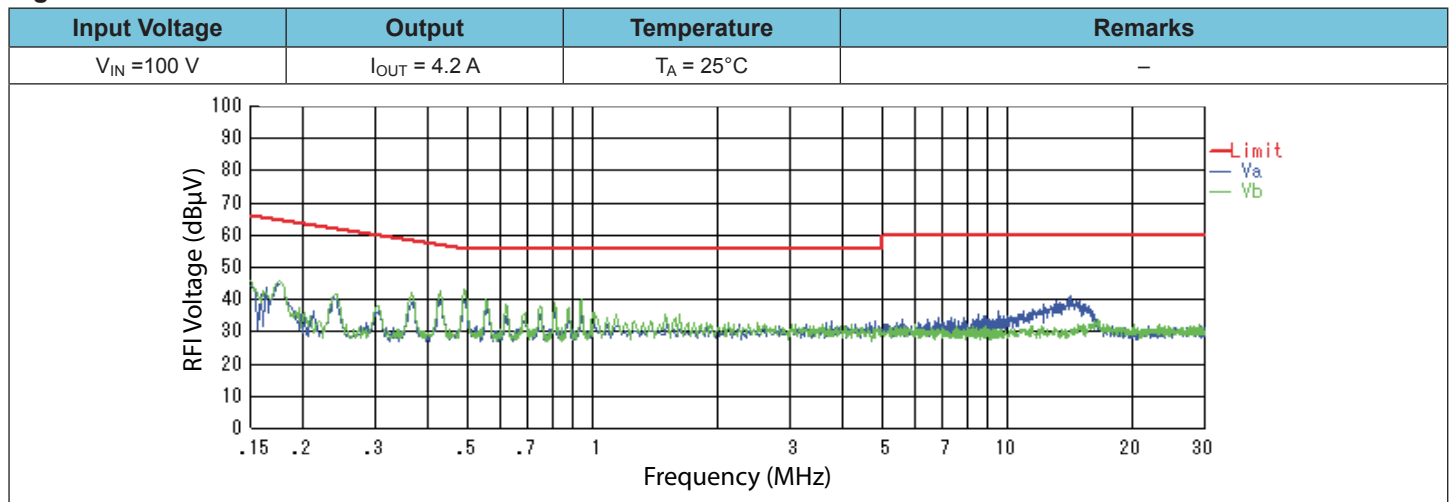

Figure 19. Conduction Noise 230 V

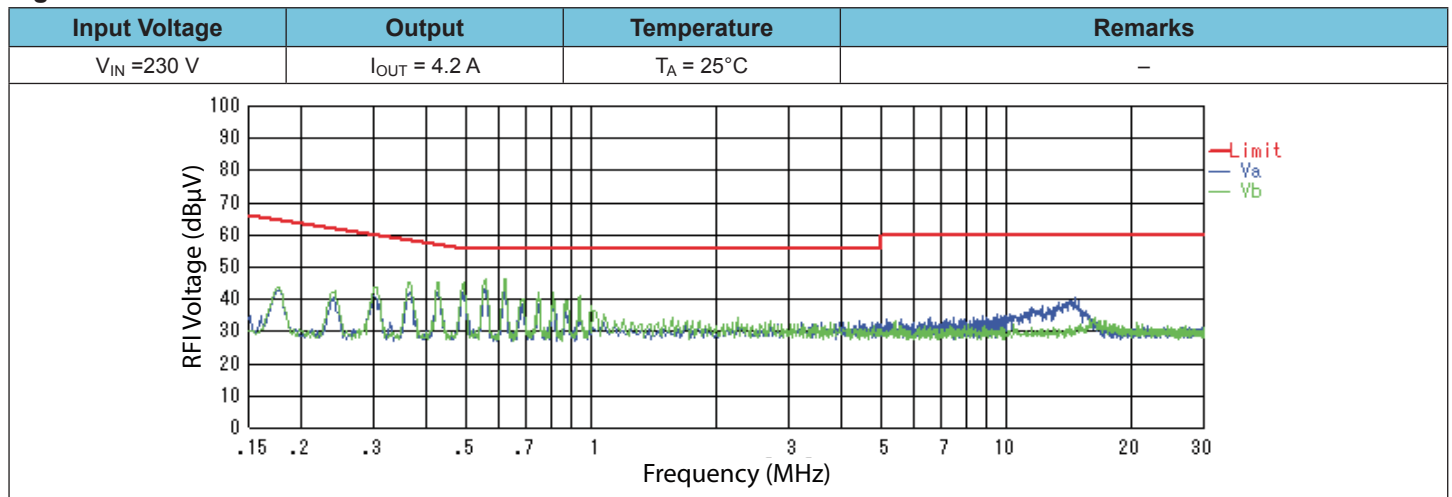

Table 6. Other Characteristics
(At $T_A = 25^\circ\text{C}$)

Test Item	Conditions		Test Results			Specification	Remarks
	V_{IN}	I_{LOAD}	P-S	P-E	S-E		
Withstand Voltage	-	-	3.0 kV / 3.6 kV	1.5 kV / 1.8 kV	0.5 kV / 0.6 kV	P-S: 3 kV for 1 minute 3.6 kV for 1 second P-E: 1.5 kV for 1 minute 1.8 kV for 1 second S-E: 500 V for 1 minute 600 V for 1 second	-
Leakage Current at Withstand Voltage	-	-	1.56 mA / 1.70 mA	1.08 mA / 1.16 mA	0.17 mA / 0.21 mA	$\leq 15\text{ mA}$	-
Insulation Resistance	-	-	$\geq 1000\text{ M}\Omega$	$\geq 1000\text{ M}\Omega$	$\geq 1000\text{ M}\Omega$	$\geq 100\text{ M}\Omega$ at 500 VDC Megger	-

Table 7. Output under Dynamic Load

Test Item	Conditions		Test Results			Specification	Remarks
	V_{IN}	I_{LOAD}	24 V				
Output Voltage at $T_A = -10^\circ\text{C}$	Min	0 A to 8.4 A for 10 ms	23.75 V / 24.25 V			-	Figure 20
Output Voltage at $T_A = 60^\circ\text{C}$	Min	0 A to 8.4 A for 10 ms	23.71 V / 24.07 V			-	Figure 20

Figure 20. Dynamic Load

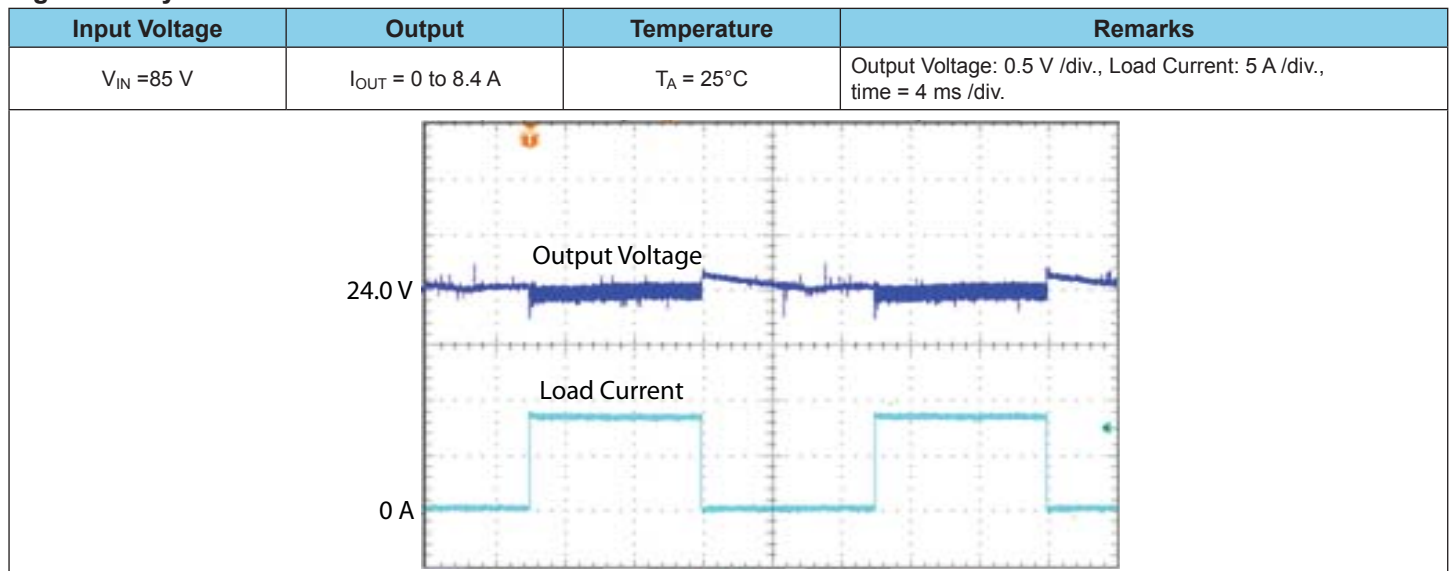

Important Information



- The products described in this document are built-in type DC stabilized power supplies with special structures and are designed for installation in equipment. Be sure to use the products only for installation in equipment.
- The products should be handled only by persons who have competent electrical knowledge.
- Be sure to read through all safety precaution and operation manuals before installation, operation, or maintenance and to use the products only for the intended use and in accordance with all applicable safety standards and regulations in the location of use.

Sanken reserves the right to make, from time to time, such departures from the detail specifications as may be required to permit improvements in the performance, reliability, or manufacturability of its products. Therefore, the user is cautioned to verify that the information in this publication is current before placing any order.

When using the products described herein, the applicability and suitability of such products for the intended purpose shall be reviewed at the users' responsibility.

Although Sanken undertakes to enhance the quality and reliability of its products, the occurrence of failure and defect of semiconductor products at a certain rate is inevitable.

Users of Sanken products are requested to take, at their own risk, preventative measures including safety design of the equipment or systems against any possible injury, death, fires or damages to society due to device failure or malfunction.

Sanken products listed in this publication are designed and intended for use as components in general-purpose electronic equipment or apparatus (home appliances, office equipment, telecommunication equipment, measuring equipment, etc.). Their use in any application requiring radiation hardness assurance (e.g., aerospace equipment) is not supported.

When considering the use of Sanken products in applications where higher reliability is required (transportation equipment and its control systems or equipment, fire- or burglar-alarm systems, various safety devices, etc.), contact a company sales representative to discuss and obtain written confirmation of your specifications.

The use of Sanken products without the written consent of Sanken in applications where extremely high reliability is required (aerospace equipment, nuclear power-control stations, life-support systems, etc.) is strictly prohibited.

The information included herein is believed to be accurate and reliable. Application and operation examples described in this publication are given for reference only and Sanken assumes no responsibility for any infringement of industrial property rights, intellectual property rights, or any other rights of Sanken or any third party that may result from its use. The contents in this document must not be transcribed or copied without Sanken's written consent.