

4-1 電源整流ダイオード

●面実装

V _{RM} (V)	I _F (AV) (A) ()フィン付	パッケージ	品名	I _{FSM} (A)	T _j (°C)	T _{stg} (°C)	V _F (V) max	I _F (A)	I _R (μA)	I _R (H) (μA)	T _j (°C)	R _{th(j-l)} R _{th(j-c)} (°C/W)	質量 (g)
				50Hz 正弦半波単発					V _R =V _{RM} max	V _R =V _{RM} max			
400	2.0	面実装(SJP)	SJPM-H4	45	-40~+150		1.1	2.0	10	50	150	20	0.072

●リード挿入

V _{RM} (V)	I _F (AV) (A) ()フィン付	パッケージ Axial (ボディ径/リード径)	品名	I _{FSM} (A)	T _j (°C)	T _{stg} (°C)	V _F (V) max	I _F (A)	I _R (μA)	I _R (H) (μA)	T _j (°C)	R _{th(j-l)} R _{th(j-c)} (°C/W)	質量 (g)
				50Hz 正弦半波単発					V _R =V _{RM} max	V _R =V _{RM} max			
100	1.0	Axial (φ 2.7/φ 0.78)	EM 1Y	45	-40~+150		0.97	1.0	10	500	150	17	0.3
	3.0	Axial (φ 6.5/φ 1.4)	RM 4Y	200	-40~+150		0.95	3.0	10	50	150	8.0	1.2
200	1.0	Axial (φ 2.4/φ 0.6)	AM01Z	35	-40~+150		0.98	1.0	10	50	100(Ta)	22	0.13
	1.0	Axial (φ 2.7/φ 0.6)	EM01Z	45	-40~+150		0.97	1.0	10	50	100	20	0.2
	1.0	Axial (φ 2.7/φ 0.78)	EM 1Z	45	-40~+150		0.97	1.0	10	500	150	17	0.3
	1.0	Axial (φ 4.0/φ 0.78)	RM 1Z	50	-40~+150		0.95	1.0	5	50	100	15	0.4
	1.2	Axial (φ 4.0/φ 0.98)	RO 2Z	80	-40~+150		0.92	1.5	10	50	100(Ta)	12	0.61
	1.2	Axial (φ 4.0/φ 0.98)	RM 2Z	100	-40~+150		0.91	1.5	10	50	100	12	0.6
	1.5	Axial (φ 4.0/φ 0.78)	RM 10Z	120	-40~+150		0.91	1.5	10	50	100(Ta)	15	0.4
	3.0	Axial (φ 6.5/φ 1.4)	RM 4Z	200	-40~+150		0.95	3.0	10	50	100(Ta)	8.0	1.2
	10	TO-220F (Center-tap)	FMM-22S, R	100	-40~+150		1.1	5.0	10	100	150	4.0	2.1
400	1.0	Axial (φ 2.4/φ 0.6)	AM01	35	-40~+150		0.98	1.0	10	50	100(Ta)	22	0.13
	1.0	Axial (φ 2.7/φ 0.6)	EM01	45	-40~+150		0.97	1.0	10	50	100(Ta)	20	0.2
	1.0	Axial (φ 2.7/φ 0.78)	EM 1	45	-40~+150		0.97	1.0	10	500	150	17	0.3
	1.0	Axial (φ 4.0/φ 0.78)	RM 1	50	-40~+150		0.95	1.0	5.0	50	100	15	0.4
	1.2	Axial (φ 2.7/φ 0.78)	EM 2	80	-40~+150		0.92	1.2	10	500	150	17	0.3
	1.2	Axial (φ 4.0/φ 0.98)	RO 2	80	-40~+150		0.92	1.5	10	50	100(Ta)	12	0.61
	1.2	Axial (φ 4.0/φ 0.98)	RM 2	100	-40~+150		0.91	1.5	10	50	100	12	0.6
	1.2	Axial (φ 4.0/φ 0.78)	RM 10	150	-40~+150		0.91	1.5	10	50	100	15	0.4
	3.0	Axial (φ 6.5/φ 1.4)	RM 4	200	-40~+150		0.95	3.0	10	50	150	8.0	1.2
10	TO-220F (Center-tap)	FMM-24S, R	100	-40~+150		1.1	5.0	10	100	150	4.0	2.1	
600	1.0	Axial (φ 2.4/φ 0.6)	AM01A	35	-40~+150		0.98	1.0	10	50	100(Ta)	22	0.13
	1.0	Axial (φ 2.7/φ 0.6)	EM01A	45	-40~+150		0.97	1.0	10	50	100(Ta)	20	0.2
	1.0	Axial (φ 2.7/φ 0.78)	EM 1A	45	-40~+150		0.97	1.0	10	500	150	17	0.3
	1.0	Axial (φ 4.0/φ 0.78)	RM 1A	50	-40~+150		0.95	1.0	5.0	50	100	15	0.4
	1.2	Axial (φ 2.7/φ 0.78)	EM 2A	80	-40~+150		0.92	1.2	10	50	100	17	0.3
	1.2	Axial (φ 4.0/φ 0.78)	RM 11A	100	-40~+150		0.92	1.5	10	50	100	15	0.4
	1.2	Axial (φ 4.0/φ 0.98)	RM 2A	100	-40~+150		0.91	1.5	10	50	100	12	0.6
	1.2	Axial (φ 4.0/φ 0.78)	RM 10A	150	-40~+150		0.91	1.5	10	50	100	15	0.4
	3.0	Axial (φ 6.5/φ 1.4)	RM 4A	200	-40~+150		0.95	3.0	10	50	150	8.0	1.2
	3.2	Axial (φ 6.5/φ 1.4)	RM 4AM	350	-40~+150		0.92	3.5	10	50	100	8.0	1.2
10	TO-220F (Center-tap)	FMM-26S, R	100	-40~+150		1.1	5.0	10	100	150	4.0	2.1	
800	0.8	Axial (φ 4.0/φ 0.78)	RM 1B	40	-40~+150		1.2	1.0	5	50	100(Ta)	15	0.4
	1.0	Axial (φ 2.7/φ 0.78)	EM 1B	35	-40~+150		1.05	1.0	20	200	150	17	0.3
	1.2	Axial (φ 2.7/φ 0.78)	EM 2B	80	-40~+150		0.92	1.2	10	500	150	17	0.3
	1.2	Axial (φ 4.0/φ 0.98)	RO 2B	80	-40~+150		0.92	1.5	10	50	100(Ta)	12	0.61
	1.2	Axial (φ 4.0/φ 0.78)	RM 11B	100	-40~+150		0.92	1.5	10	50	100(Ta)	15	0.4
	1.2	Axial (φ 4.0/φ 0.98)	RM 2B	100	-40~+150		0.91	1.5	10	50	100	12	0.6
1000	1.2	Axial (φ 4.0/φ 0.78)	RM 10B	150	-40~+150		0.91	1.5	10	50	100(Ta)	15	0.4
	0.8	Axial (φ 4.0/φ 0.78)	RM 1C	40	-40~+150		1.2	1.0	5.0	100	100(Ta)	15	0.4
	1.0	Axial (φ 2.7/φ 0.78)	EM 1C	35	-40~+150		1.05	1.0	20	200	150	17	0.3
	1.2	Axial (φ 4.0/φ 0.98)	RO 2C	80	-40~+150		0.92	1.5	10	50	100(Ta)	12	0.61
	1.2	Axial (φ 4.0/φ 0.78)	RM 11C	100	-40~+150		0.92	1.5	10	50	100	15	0.4
	1.2	Axial (φ 4.0/φ 0.98)	RM 2C	100	-40~+150		0.91	1.5	10	50	100	12	0.6
3.0	Axial (φ 6.5/φ 1.4)	RM 4C	150	-40~+150		0.97	3.0	10	50	100	8.0	1.2	

・No. 13 Axial ($\phi 4.0 / \phi 0.78$)

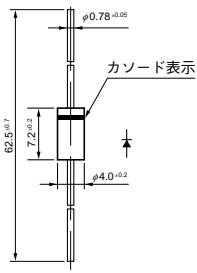

・No. 14 Axial ($\phi 4.0 / \phi 0.98$)

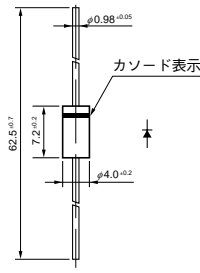

・No. 15 Axial ($\phi 6.5 / \phi 1.4$)

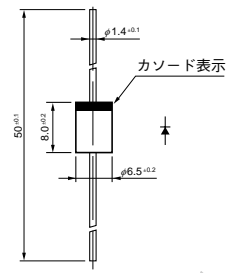

・No. 16 TO-220F (2素子)

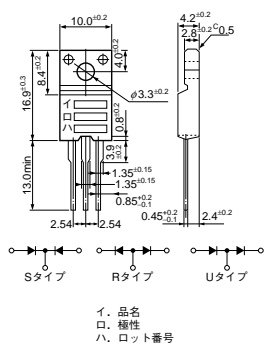

・No. 17 TO-220F (Center-tap)

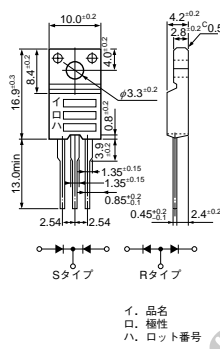

・No. 18 TO-220F2Pin

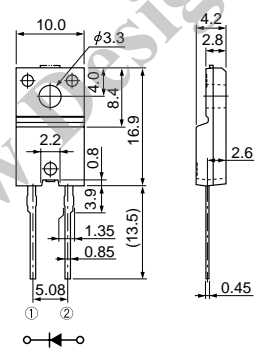

・No. 19 TO-220F2Pin (2素子)

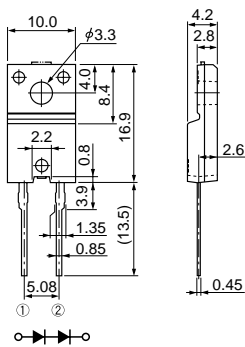

・No. 20 TO3PF

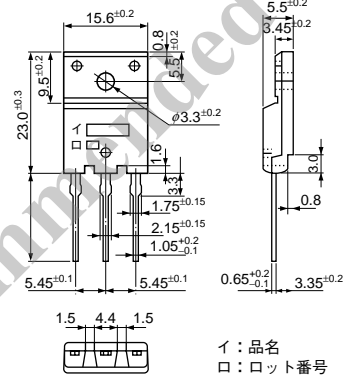

・No. 21 TO3PF2Pin

