

Using STR5A453D

15 W (15 V, 1 A)

Off-line Buck Converter

Contents

1. Introduction ----- 3

2. Features ----- 3

3. Application ----- 3

4. Power Supply Appearance of Design Example ----- 3

5. Design Example ----- 4

 5.1 Power Supply Design Specification ----- 4

 5.2 Circuit ----- 4

 5.3 Component List ----- 5

6. PCB Layout Example ----- 6

7. Performance Data ----- 7

 7.1 Load Regulation ----- 7

 7.2 Efficiency ----- 8

 7.3 Input Power at No Load ----- 9

Important Notes ----- 10

1. Introduction

STR5A450D series are a power IC incorporating a power MOSFET and a current mode PWM controller IC of the non-isolated converters.

This document describes a design example for a universal input, 15 W (15 V, 1 A), non-isolated buck converter. For this design example, STR5A453D is used.

This document contains a power supply design specification, a component list, a PCB layout and typical performance data.

2. Features

- Non-isolation
- Buck Converter
- Few External Components Count
Overcurrent detection resistor and operational amplifier are incorporated in STR5A450D series.
- High efficiency in All Load
The oscillation mode of the STR5A450D series automatically changes according to load (Green mode and burst oscillation mode).

3. Applications

- Small Home Appliance
- White Goods
- Auxiliary Power Supply
- Motor Control
- Other Switching Mode Power Supply

4. Power Supply Appearance of Design Example

◆ Top View

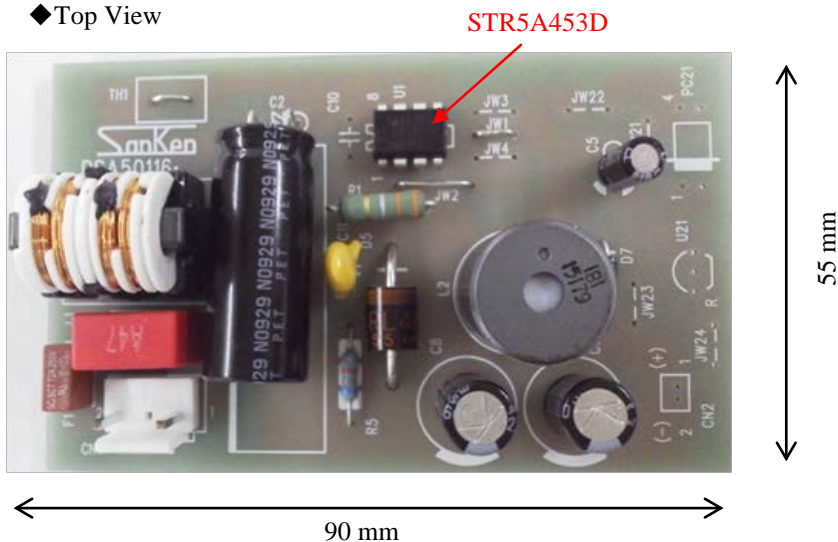

5. Design Example

5.1 Power Supply Design Specification

Description	Symbol	Min	Typ.	Max.	Unit	Remarks
Input						
Input Voltage	V_{IN}	85		265	V	
Frequency	f_{LINE}	47	50/60	63	Hz	
Output						
Name Plate Voltage	V_{NP}		15		V	
Name Plate Current	I_{NP}		1		A	
Output Power	P_{OUT}		15		W	
Efficiency						
Average Efficiency	η		83.4		%	$T_A = 25\text{ }^\circ\text{C}, 230\text{VAC}$
Efficiency at 10% Load	$\eta_{(10)}$		77.0		%	$T_A = 25\text{ }^\circ\text{C}, 230\text{VAC}$
Input Power at No Load	P_0		58.4		mW	$T_A = 25\text{ }^\circ\text{C}, 230\text{VAC}$

5.2 Circuit

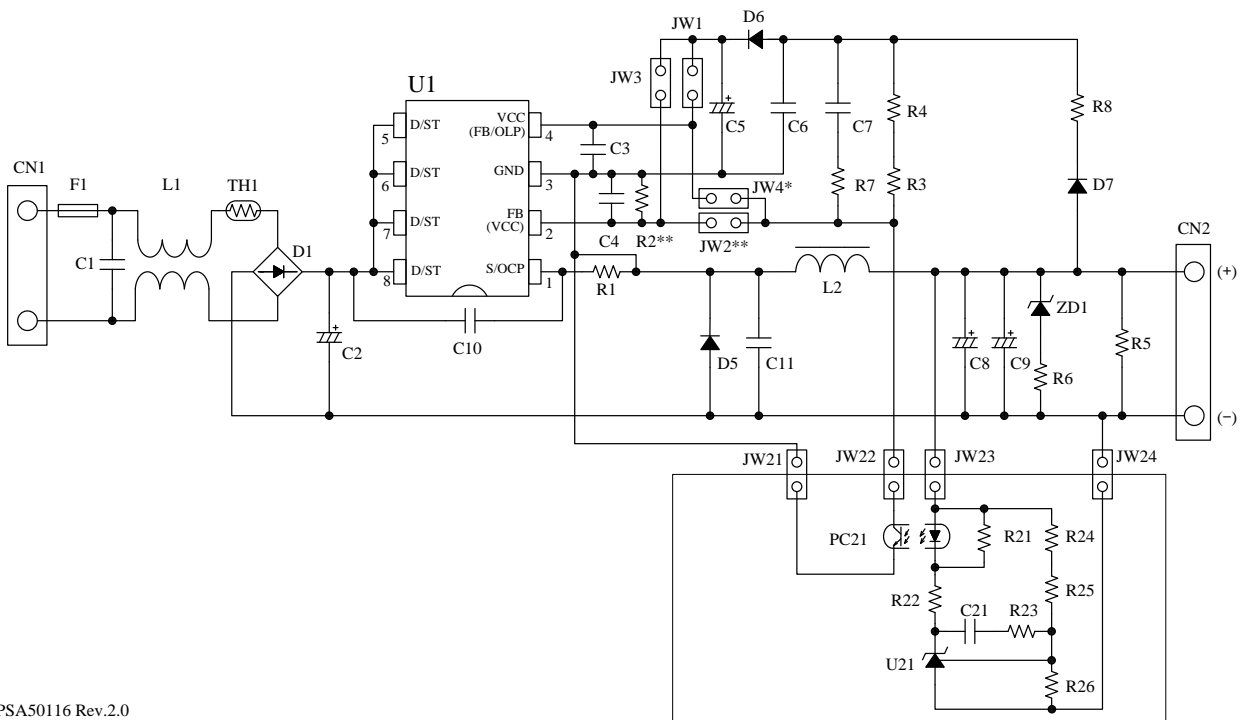

PSA50116 Rev.2.0

5.3 Component List

Symbol	Component	Characteristics	Product	Manufacture
F1	Fuse	250 V, 2 A		
TH1	Power thermistor	Short		
C1	Film capacitor	275 VAC, 0.1 μ F	FTX2	WURTH
C2	Electrolytic capacitor	400 V, 56 μ F	QXW	Rubycon
C3	Ceramic capacitor	Open		
C4	Ceramic capacitor	50 V, 470 pF	X7R	WURTH
C5	Electrolytic capacitor	50 V, 10 μ F	PX	Rubycon
C6	Ceramic capacitor	50 V, 2.2 μ F, 2012	GRM219B	Murata
C7	Ceramic capacitor	Open		
C8	Electrolytic capacitor	25 V, 470 μ F	YXH	Rubycon
C9	Electrolytic capacitor	25 V, 470 μ F	YXH	Rubycon
C10	Ceramic capacitor	Open		
C11	Ceramic capacitor	2 kV, 22 pF		
C21	Ceramic capacitor	Open		
D1	Diode bridge	600 V, 1 A	S1NBC60	SHINDENGEN
D5	Fast recovery diode	600V, 3 A	RL4A	Sanken
D6	Fast recovery diode	90V, 1 A	SJPB-D9	Sanken
D7	Fast recovery diode	600 V, 0.5 A	AG01A	Sanken
ZD1	Zener diode	$V_z = 22$ V	SJPZ-E20	Sanken
L1	CM inductor	10 mH	WEFC	WURTH
L2	Inductor	180 μ H	16RHBP	TOKO
R1	Resistor	0.33 Ω , 1 W	RSMF	AKAHANE
R2	Resistor	10k Ω , 1/8 W, 1608		
R3	Resistor	47k Ω , 1/8 W, 1608		
R4	Resistor	4.7k Ω , 1/8 W, 1608		
R5	Resistor	6.8k Ω , 1/2 W		
R6	Resistor	0 Ω , 1/8 W, 1608		
R7	Resistor	Open		
R8	Resistor	0 Ω , 1/8 W, 1608		
R21 ~ R26	Resistor	Open		
U1	AC/DC convertor IC	650 V, 1.9 Ω	STR5A453D	Sanken
U21	Shunt regulator	Open		
PC21	Photo-coupler	Open		
JW1, JW2		Short		
JW3, JW4		Open		
JW21 ~ JW24		Open		

6. PCB Layout Example

See Section 5.2 about the circuit of PCB layout example.

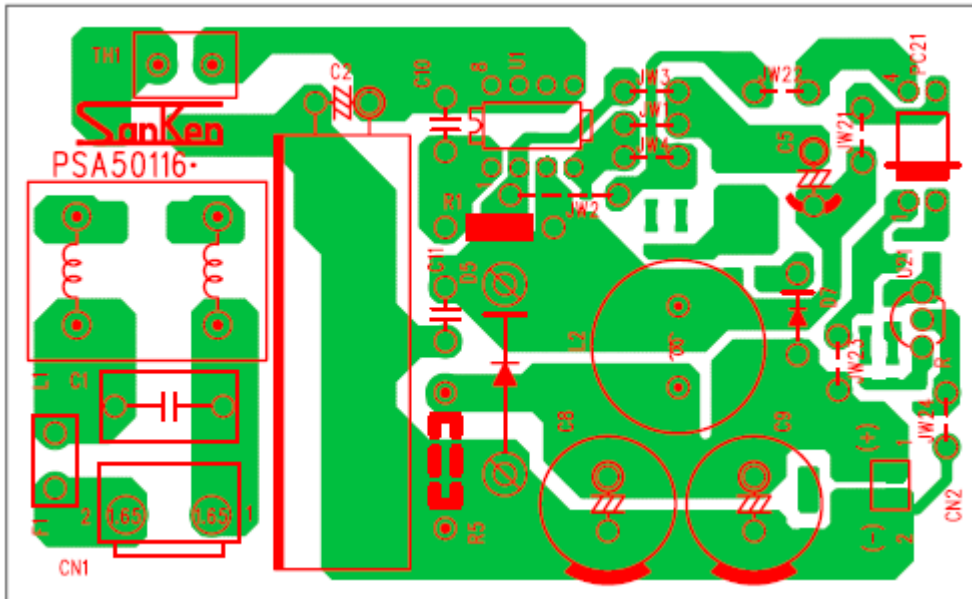

(a) Top View

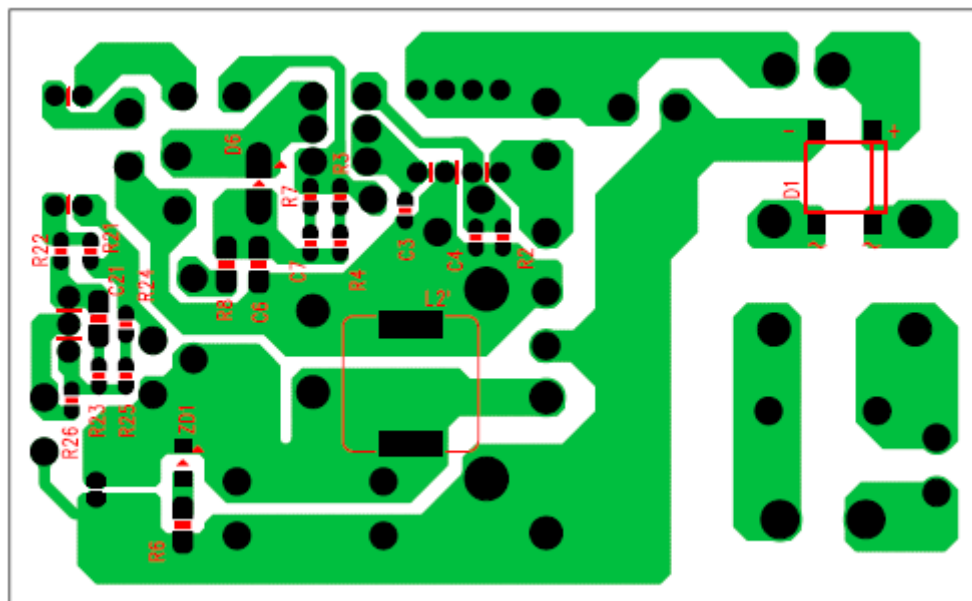

(b) Bottom View

Figure 6-1. PCB Layout Example

7. Performance Data

All data in this document was measured at room temperature and 50 Hz line frequency.

7.1 Load Regulation

Breeder resistor, R5 is 6.8 kΩ.

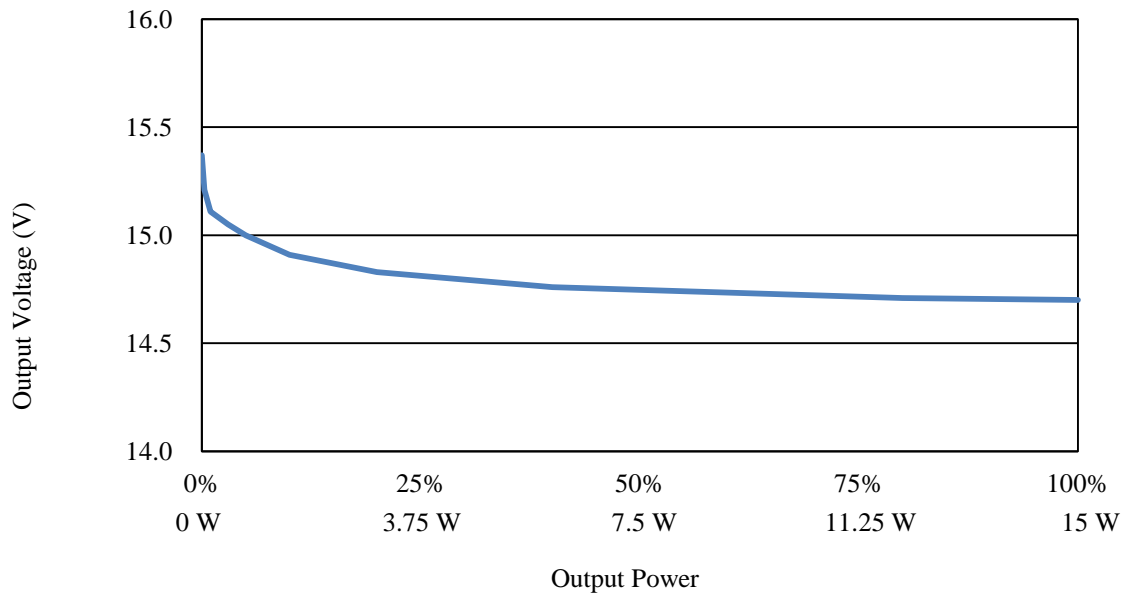

Figure 7-1. Load Regulation (100 VAC)

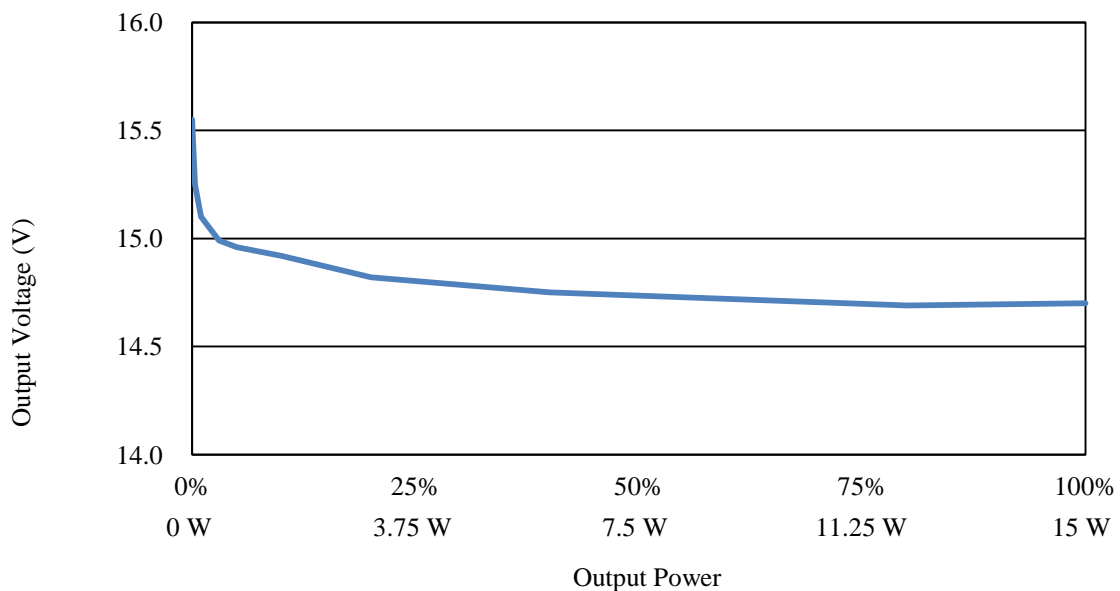

Figure 7-2. Load Regulation (230 VAC)

7.2 Efficiency

Figure 7-3 and Figure 7-4 show the efficiency depending on output power in normal operation.

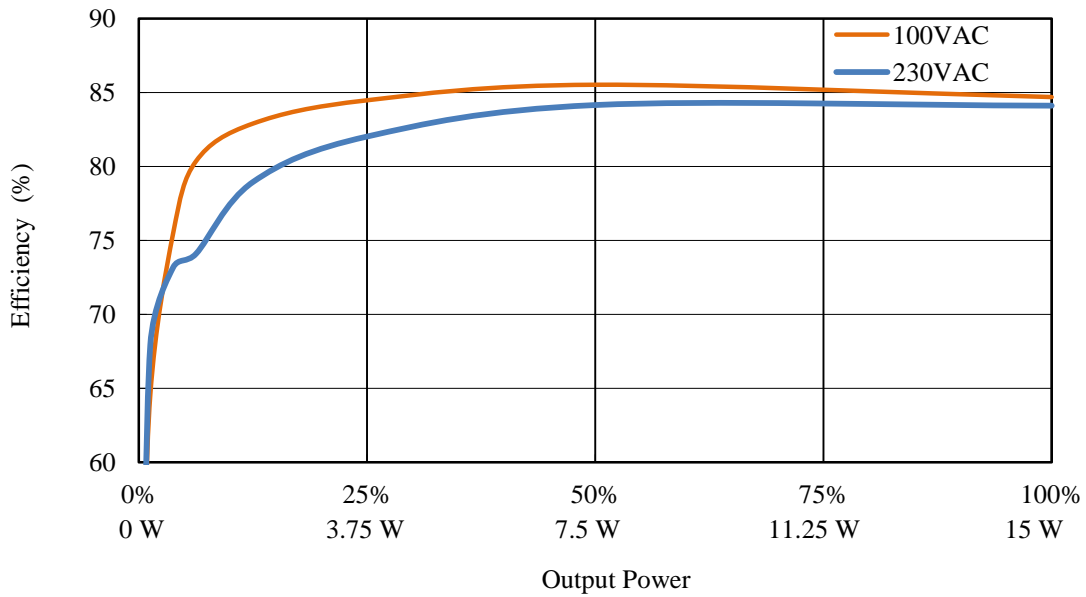

Figure 7-3. Efficiency vs. Output Power

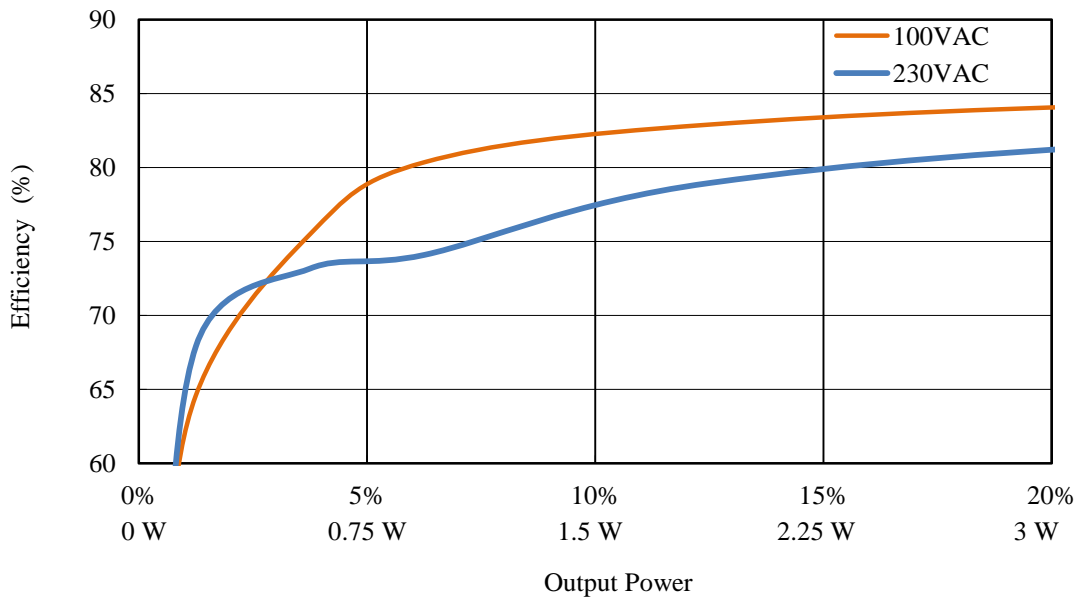

Figure 7-4. Efficiency vs. Output Power in Light Load

7.3 Input Power at No Load

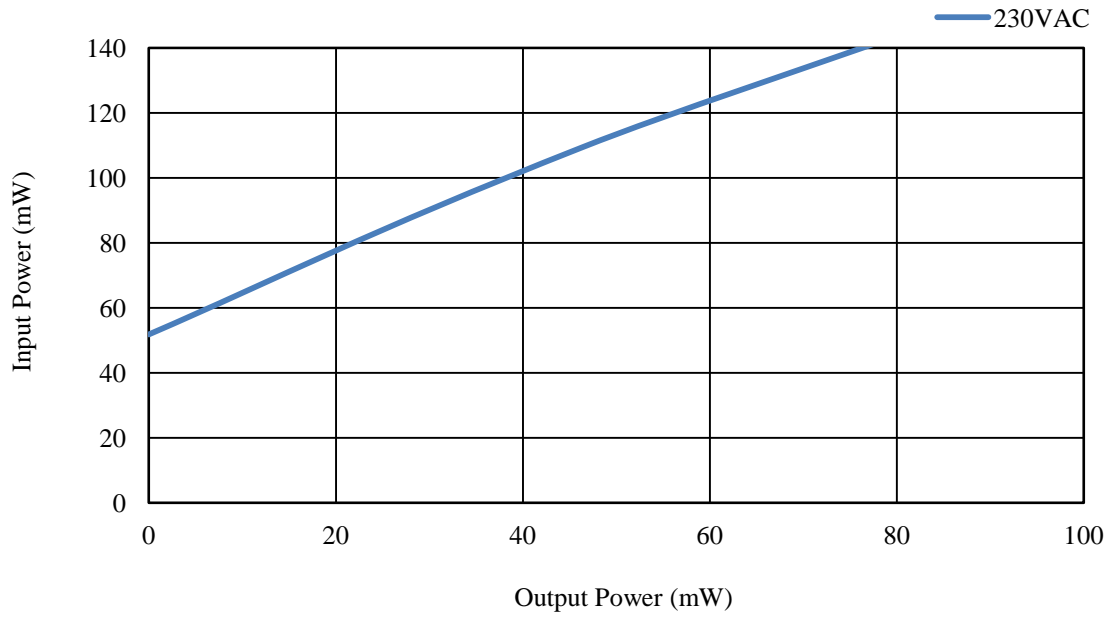

Figure 7-5. Input Power vs. Output Power

Important Notes

- All data, illustrations, graphs, tables and any other information included in this document as to Sanken's products listed herein (the "Sanken Products") are current as of the date this document is issued. All contents in this document are subject to any change without notice due to improvement of the Sanken Products, etc. Please make sure to confirm with a Sanken sales representative that the contents set forth in this document reflect the latest revisions before use.
- The Sanken Products are intended for use as components of general purpose electronic equipment or apparatus (such as home appliances, office equipment, telecommunication equipment, measuring equipment, etc.). Prior to use of the Sanken Products, please put your signature, or affix your name and seal, on the specification documents of the Sanken Products and return them to Sanken. When considering use of the Sanken Products for any applications that require higher reliability (such as transportation equipment and its control systems, traffic signal control systems or equipment, disaster/crime alarm systems, various safety devices, etc.), you must contact a Sanken sales representative to discuss the suitability of such use and put your signature, or affix your name and seal, on the specification documents of the Sanken Products and return them to Sanken, prior to the use of the Sanken Products. The Sanken Products are not intended for use in any applications that require extremely high reliability such as: aerospace equipment; nuclear power control systems; and medical equipment or systems, whose failure or malfunction may result in death or serious injury to people, i.e., medical devices in Class III or a higher class as defined by relevant laws of Japan (collectively, the "Specific Applications"). Sanken assumes no liability or responsibility whatsoever for any and all damages and losses that may be suffered by you, users or any third party, resulting from the use of the Sanken Products in the Specific Applications or in manner not in compliance with the instructions set forth herein.
- In the event of using the Sanken Products by either (i) combining other products or materials therewith or (ii) physically, chemically or otherwise processing or treating the same, you must duly consider all possible risks that may result from all such uses in advance and proceed therewith at your own responsibility.
- Although Sanken is making efforts to enhance the quality and reliability of its products, it is impossible to completely avoid the occurrence of any failure or defect in semiconductor products at a certain rate. You must take, at your own responsibility, preventative measures including using a sufficient safety design and confirming safety of any equipment or systems in/for which the Sanken Products are used, upon due consideration of a failure occurrence rate or derating, etc., in order not to cause any human injury or death, fire accident or social harm which may result from any failure or malfunction of the Sanken Products. Please refer to the relevant specification documents and Sanken's official website in relation to derating.
- No anti-radioactive ray design has been adopted for the Sanken Products.
- No contents in this document can be transcribed or copied without Sanken's prior written consent.
- The circuit constant, operation examples, circuit examples, pattern layout examples, design examples, recommended examples, all information and evaluation results based thereon, etc., described in this document are presented for the sole purpose of reference of use of the Sanken Products and Sanken assumes no responsibility whatsoever for any and all damages and losses that may be suffered by you, users or any third party, or any possible infringement of any and all property rights including intellectual property rights and any other rights of you, users or any third party, resulting from the foregoing.
- All technical information described in this document (the "Technical Information") is presented for the sole purpose of reference of use of the Sanken Products and no license, express, implied or otherwise, is granted hereby under any intellectual property rights or any other rights of Sanken.
- Unless otherwise agreed in writing between Sanken and you, Sanken makes no warranty of any kind, whether express or implied, including, without limitation, any warranty (i) as to the quality or performance of the Sanken Products (such as implied warranty of merchantability, or implied warranty of fitness for a particular purpose or special environment), (ii) that any Sanken Product is delivered free of claims of third parties by way of infringement or the like, (iii) that may arise from course of performance, course of dealing or usage of trade, and (iv) as to any information contained in this document (including its accuracy, usefulness, or reliability).
- In the event of using the Sanken Products, you must use the same after carefully examining all applicable environmental laws and regulations that regulate the inclusion or use of any particular controlled substances, including, but not limited to, the EU RoHS Directive, so as to be in strict compliance with such applicable laws and regulations.
- You must not use the Sanken Products or the Technical Information for the purpose of any military applications or use, including but not limited to the development of weapons of mass destruction. In the event of exporting the Sanken Products or the Technical Information, or providing them for non-residents, you must comply with all applicable export control laws and regulations in each country including the U.S. Export Administration Regulations (EAR) and the Foreign Exchange and Foreign Trade Act of Japan, and follow the procedures required by such applicable laws and regulations.
- Sanken assumes no responsibility for any troubles, which may occur during the transportation of the Sanken Products including the falling thereof, out of Sanken's distribution network.
- Although Sanken has prepared this document with its due care to pursue the accuracy thereof, Sanken does not warrant that it is error free and Sanken assumes no liability whatsoever for any and all damages and losses which may be suffered by you resulting from any possible errors or omissions in connection with the contents included herein.
- Please refer to the relevant specification documents in relation to particular precautions when using the Sanken Products, and refer to our official website in relation to general instructions and directions for using the Sanken Products.
- All rights and title in and to any specific trademark or tradename belong to Sanken or such original right holder(s).