

2SA1493

シリコンPNPエピタキシャルプレーナ型トランジスタ (2SC3857とコンプリメンタリ)

用途：オーディオ、一般用

絶対最大定格 (Ta = 25)

記号	規格値	単位
V _{CB0}	- 200	V
V _{CEO}	- 200	V
V _{EBO}	- 6	V
I _C	- 15	A
I _B	- 5	A
P _C	150(T _C = 25)	W
T _j	150	
T _{stg}	- 55 ~ + 150	

電気的特性 (Ta = 25)

記号	試験条件	規格値	単位
I _{CB0}	V _{CB} = - 200V	- 100max	μA
I _{EBO}	V _{EB} = - 6V	- 100max	μA
V _{(BR)CEO}	I _C = - 50mA	- 200min	V
h _{FE}	V _{CE} = - 4V, I _C = - 5A	50min	
V _{CE(sat)}	I _C = - 10A, I _B = - 1A	- 3.0max	V
f _r	V _{CE} = - 12V, I _E = 0.5A	20typ	MHz
COB	V _{CB} = - 10V, f = 1MHz	400typ	pF

ランク O(50~100), P(70~140), Y(90~180)

外形図 MT-200

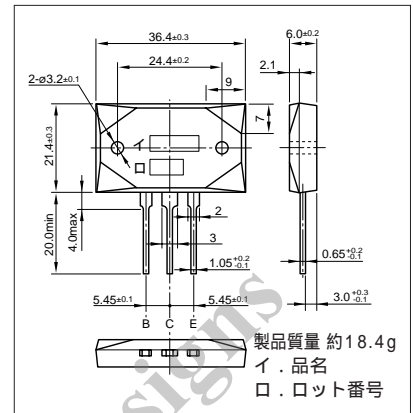

代表的スイッチング特性 (エミッタ接地)

V _{CC} (V)	R _L (Ω)	I _C (A)	V _{BB1} (V)	V _{BB2} (V)	I _{B1} (mA)	I _{B2} (mA)	t _{on} (μs)	t _{stg} (μs)	t _f (μs)
-60	12	-5	-10	5	-500	500	0.3typ	0.9typ	0.2typ

I_C-V_{CE}特性 (代表例)

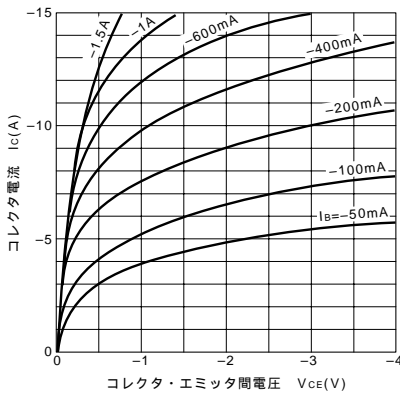

V_{CE(sat)}-I_B特性 (代表例)

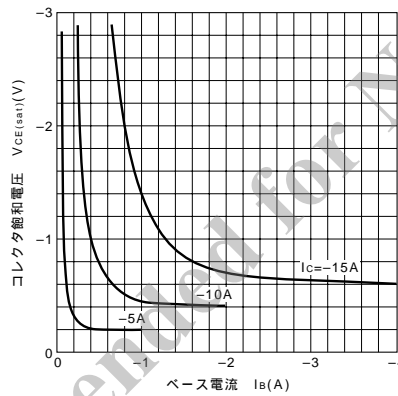

I_C-V_{BE}温度特性 (代表例)

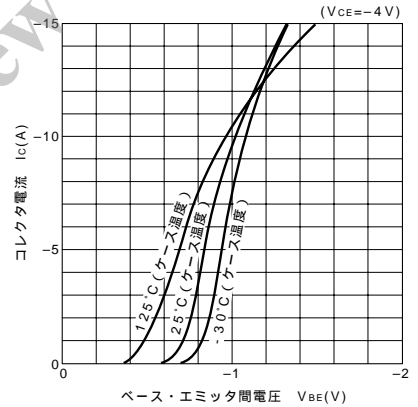

h_{FE}-I_C特性 (代表例)

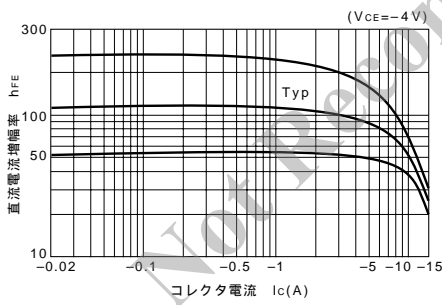

h_{FE}-I_C温度特性 (代表例)

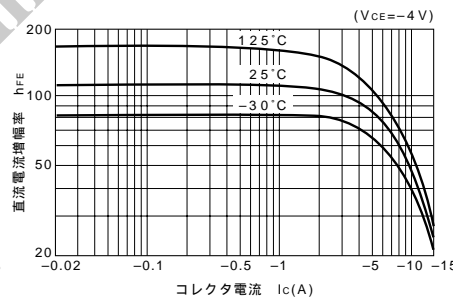

θ_{j-a}-t特性

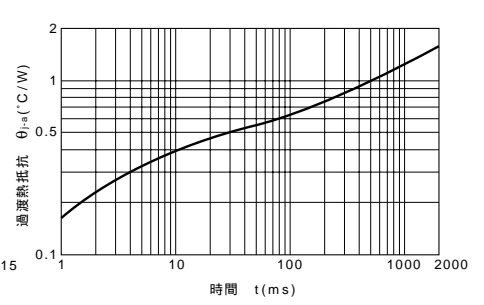

f_T-I_E特性 (代表例)

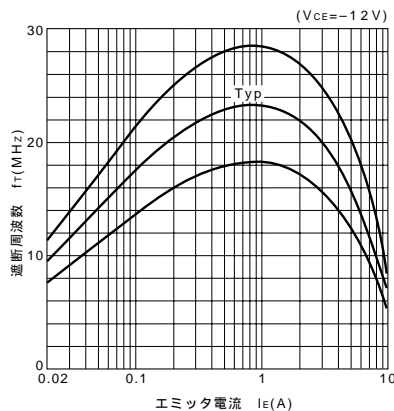

ASO曲線 (単発パルス)

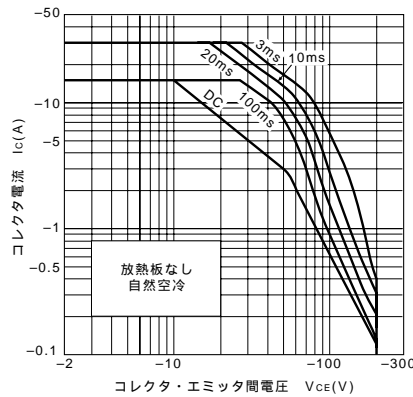

P_C-T_a定格

