

# 2SA1673

シリコンPNPエピタキシャルプレーナ型トランジスタ (2SC4388とコンプリメンタリ)

用途：オーディオ、一般用

絶対最大定格 (Ta = 25 )

記号	規格値	単位
V <sub>CB0</sub>	- 180	V
V <sub>CE0</sub>	- 180	V
V <sub>EB0</sub>	- 6	V
I <sub>c</sub>	- 15	A
I <sub>B</sub>	- 4	A
P <sub>c</sub>	85(T <sub>c</sub> = 25 )	W
T <sub>j</sub>	150	
T <sub>stg</sub>	- 55 ~ + 150	

電気的特性 (Ta = 25 )

記号	試験条件	規格値	単位
I <sub>CB0</sub>	V <sub>CB</sub> = - 180V	- 10max	μA
I <sub>EB0</sub>	V <sub>EB</sub> = - 6V	- 10max	μA
V <sub>(BR)CEO</sub>	I <sub>c</sub> = - 50mA	- 180min	V
h <sub>FE</sub>	V <sub>CE</sub> = - 4V, I <sub>c</sub> = - 3A	50min	
V <sub>CE(sat)</sub>	I <sub>c</sub> = - 5A, I <sub>B</sub> = - 0.5A	- 2.0max	V
f <sub>r</sub>	V <sub>CE</sub> = - 12V, I <sub>E</sub> = 0.5A	20typ	MHz
C <sub>OB</sub>	V <sub>CB</sub> = - 10V, f = 1MHz	500typ	pF

ランク  $\bar{O}$ (50 ~ 100), P(70 ~ 140), Y(90 ~ 180)

外形図 FM100(TO3PF)

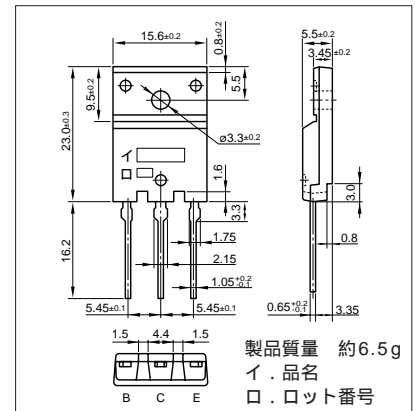

代表的スイッチング特性 (エミッタ接地)

V <sub>CC</sub> (V)	R <sub>L</sub> (Ω)	I <sub>c</sub> (A)	V <sub>BB1</sub> (V)	V <sub>BB2</sub> (V)	I <sub>B1</sub> (A)	I <sub>B2</sub> (A)	t <sub>on</sub> (μs)	t <sub>stg</sub> (μs)	t <sub>f</sub> (μs)
-40	4	-10	-10	5	-1	1	0.6typ	0.9typ	0.2typ

I<sub>c</sub>-V<sub>CE</sub>特性 (代表例)

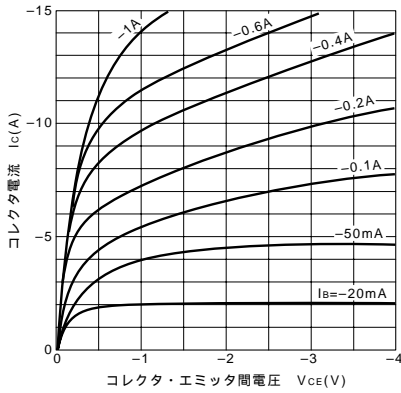

V<sub>CE(sat)</sub>-I<sub>B</sub>特性 (代表例)

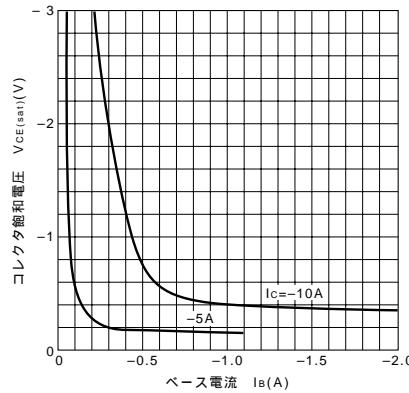

I<sub>c</sub>-V<sub>BE</sub>温度特性 (代表例)

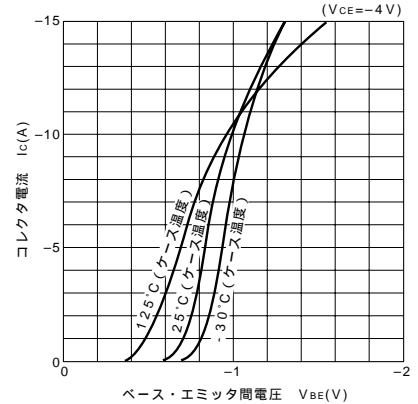

h<sub>FE</sub>-I<sub>c</sub>特性 (代表例)

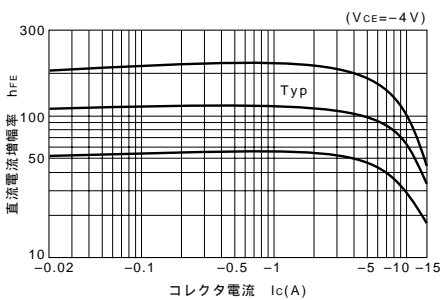

h<sub>FE</sub>-I<sub>c</sub>温度特性 (代表例)

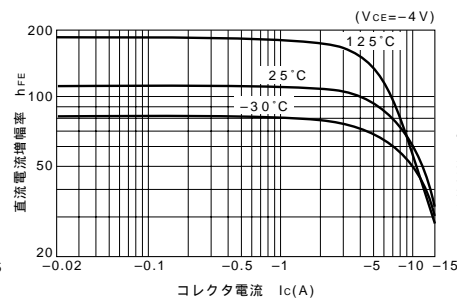

θ<sub>j-a</sub>-t特性

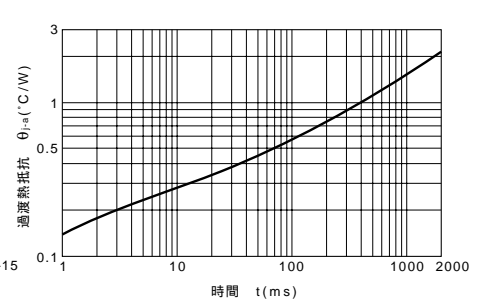

f<sub>T</sub>-I<sub>E</sub>特性 (代表例)

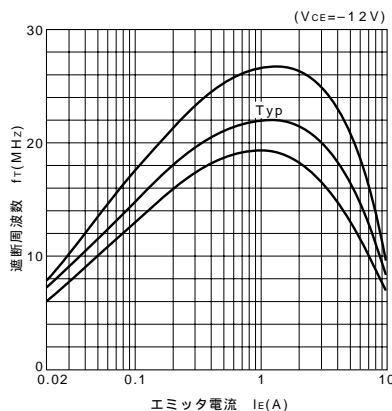

ASO曲線 (単発パルス)

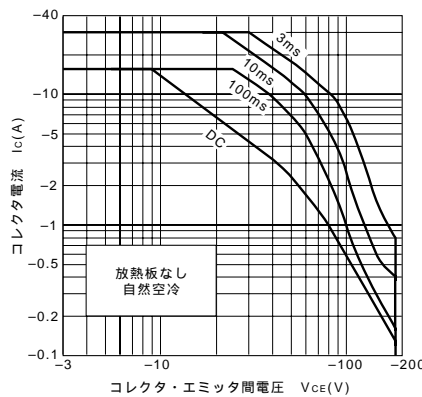

P<sub>c</sub>-T<sub>a</sub>定格

