

# 2SA1859/1859A

シリコンPNPエピタキシャルプレーナ型トランジスタ (2SC4883/4883Aとコンプリメンタリ)

用途：オーディオ出力ドライバ、TV速度変調

## 絶対最大定格 (Ta = 25 )

記号	規格値		単位
	2SA1859	2SA1859A	
VcBo	- 150	- 180	V
VcEO	- 150	- 180	V
VEBO	- 6		V
Ic	- 2		A
Ib	- 1		A
Pc	20(Tc = 25 )		W
Tj	150		
Tstg	- 55 ~ + 150		

## 電気的特性 (Ta = 25 )

記号	試験条件	規格値		単位
		2SA1859	2SA1859A	
IcBo	Vcb =	- 10max		μA
IEBO	VEB = - 6V	- 10max		μA
V(BR)CEO	Ic = - 10mA	- 150min	- 180min	V
hFE	VCE = - 10V, Ic = - 0.7A	60 ~ 240		
VCE(sat)	Ic = - 0.7A, Ib = - 70mA	- 1.0max		V
fr	VCE = - 12V, Ie = 0.7A	60typ		MHz
COB	Vcb = - 10V, f = 1MHz	30typ		pF

## 外形図 FM20(TO220F)

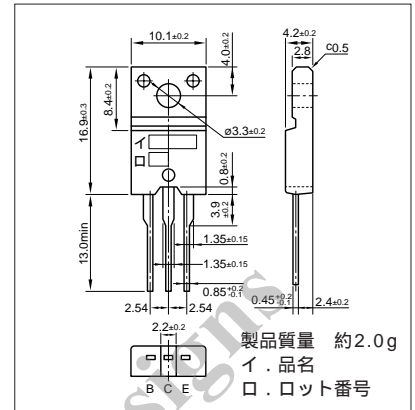

## 代表的スイッチング特性 (エミッタ接地)

Vcc (V)	RL (Ω)	Ic (A)	VBB1 (V)	VBB2 (V)	Ib1 (mA)	Ib2 (mA)	ton (μs)	tstg (μs)	tf (μs)
-20	20	-1	-10	5	-100	100	0.5typ	1.0typ	0.5typ

Ic-VCE特性 (代表例)

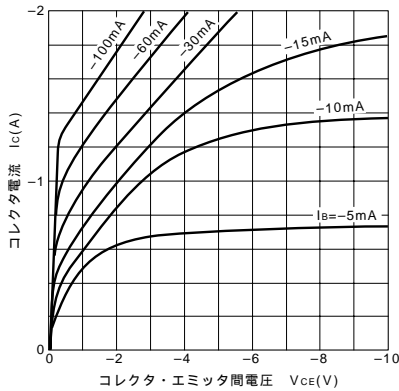

VCE(sat)-Ib特性 (代表例)

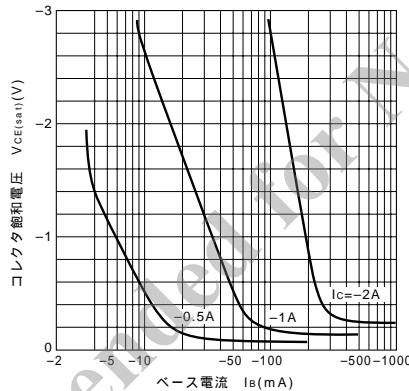

Ic-VBE温度特性 (代表例)

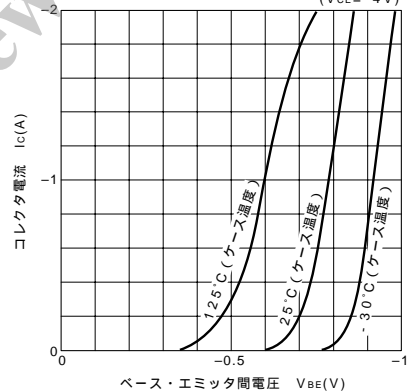

hFE-Ic特性 (代表例)

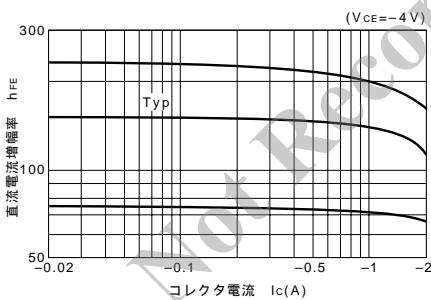

hFE-Ic温度特性 (代表例)

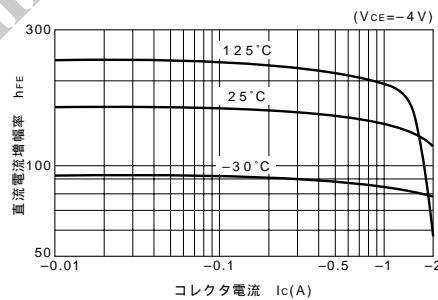

θj-a-t特性

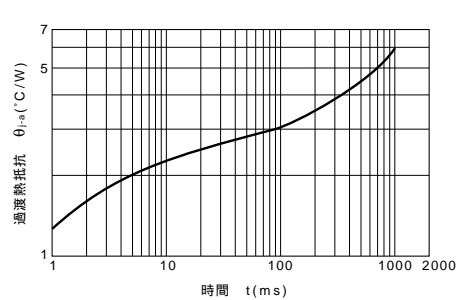

fT-Ie特性 (代表例)

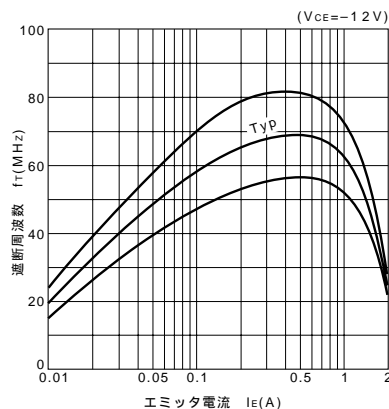

ASO曲線 (単発パルス)

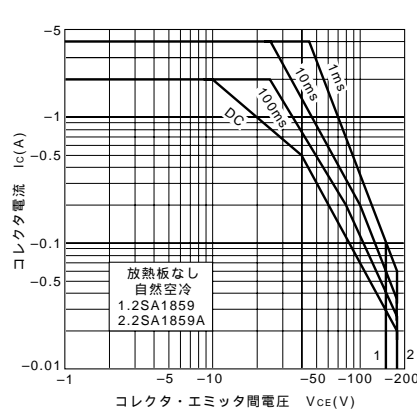

Pc-Ta定格

