

Silicon PNP Epitaxial Planar Transistor (Complement to type 2SC4886)

Application : Audio and General Purpose

■ Absolute maximum ratings (Ta=25°C)

Symbol	Ratings	Unit
V _{CB0}	-150	V
V _{CE0}	-150	V
V _{EB0}	-5	V
I _c	-14	A
I _B	-3	A
P _c	80(T _c =25°C)	W
T _j	150	°C
T _{stg}	-55 to +150	°C

■ Electrical Characteristics (Ta=25°C)

Symbol	Conditions	Ratings	Unit
I _{CB0}	V _{CB} =-150V	-100max	μA
I _{EB0}	V _{EB} =-5V	-100max	μA
V _{(BR)CEO}	I _c =-25mA	-150min	V
h _{FE}	V _{CE} =-4V, I _c =-5A	50min*	
V _{CE(sat)}	I _c =-5A, I _B =-500mA	-2.0max	V
f _r	V _{CE} =-12V, I _E =2A	50typ	MHz
C _{OB}	V _{CB} =-10V, f=1MHz	400typ	pF

*h_{FE} Rank O(50to100), P(70to140), Y(90to180)

■ Typical Switching Characteristics (Common Emitter)

V _{CC} (V)	R _L (Ω)	I _c (A)	V _{BB1} (V)	V _{BB2} (V)	I _{B1} (mA)	I _{B2} (mA)	t _{on} (μs)	t _{stg} (μs)	t _f (μs)
-60	12	-5	-10	5	-500	500	0.25typ	0.85typ	0.2typ

External Dimensions FM100(TO3PF)

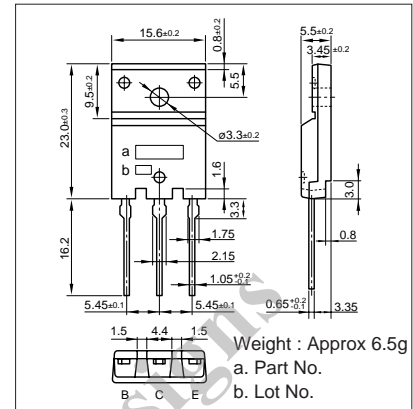

I_c-V_{CE} Characteristics (Typical)

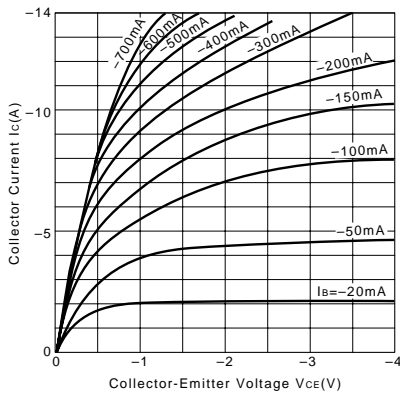

V_{CE(sat)}-I_B Characteristics (Typical)

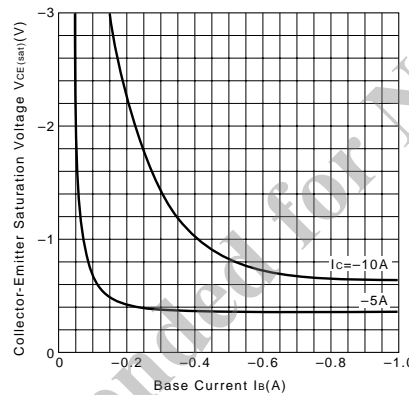

I_c-V_{BE} Temperature Characteristics (Typical)

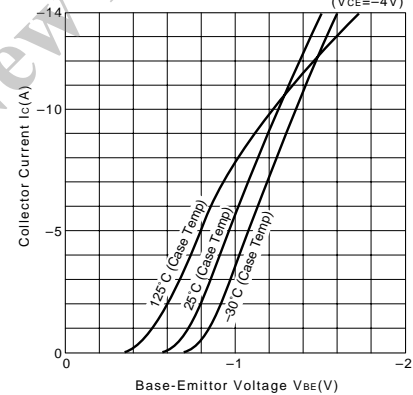

h_{FE}-I_c Characteristics (Typical)

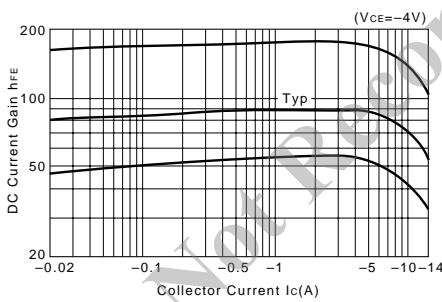

h_{FE}-I_c Temperature Characteristics (Typical)

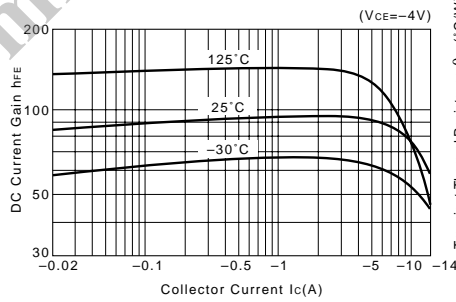

θ_{j-a}-t Characteristics

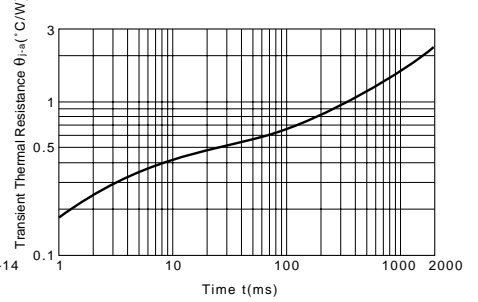

f_T-I_E Characteristics (Typical)

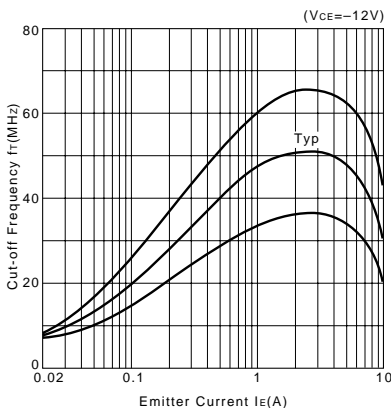

Safe Operating Area (Single Pulse)

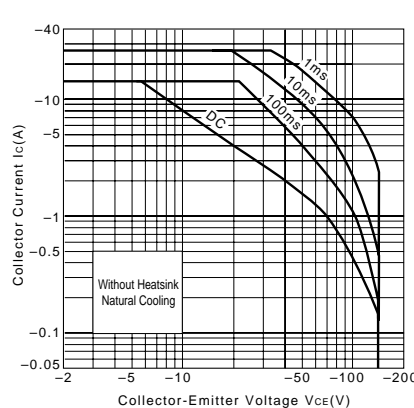

P_c-T_a Derating

