

ダーリントン

2SB1351

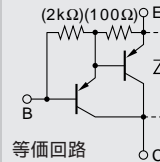

シリコンPNPエビタキシャルプレーナ型トランジスタ

用途：プリンタヘッド、ソレイド、リレー、モータ駆動、一般用

絶対最大定格 (Ta=25)

記号	規格値	単位
V _{CB0}	-60	V
V _{CEO}	-60	V
V _{EBO}	-6	V
I _C	-12(パルス-20)	A
I _B	-1	A
P _C	30(T _C =25)	W
T _J	150	
T _{stg}	-55 ~ +150	

電気的特性 (Ta=25)

記号	試験条件	規格値	単位
I _{CB0}	V _{CB} = -60V	-10max	μA
I _{EBO}	V _{EB} = -6V	-10max	mA
V(BR) _{CEO}	I _C = -10mA	-60min	V
h _{FE}	V _{CE} = -4V, I _C = -10A	2000min	
V _{CE(sat)}	I _C = -10A, I _B = -20mA	-1.5max	V
V _{BE(sat)}	I _C = -10A, I _B = -20mA	-2.0max	V
f _T	V _{CE} = -12V, I _E = 1A	130typ	MHz
C _{OB}	V _{CB} = -10V, f = 1MHz	170typ	pF

外形図 FM20(TO220F)

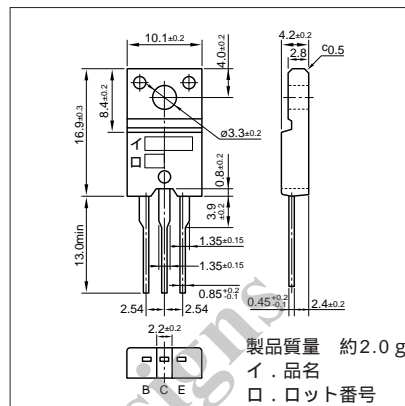

代表的スイッチング特性 (エミッタ接地)

V _{CC} (V)	R _L (Ω)	I _C (A)	V _{BB1} (V)	V _{BB2} (V)	I _{B1} (mA)	I _{B2} (mA)	t _{on} (μs)	t _{stg} (μs)	t _f (μs)
-40	4	-10	-10	5	-20	20	0.7typ	1.5typ	0.6typ

I_C-V_{CE}特性 (代表例)

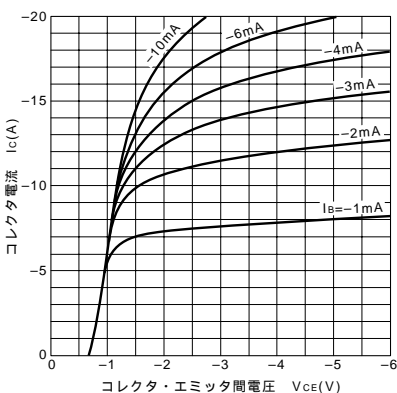

V_{CE(sat)}-I_B特性 (代表例)

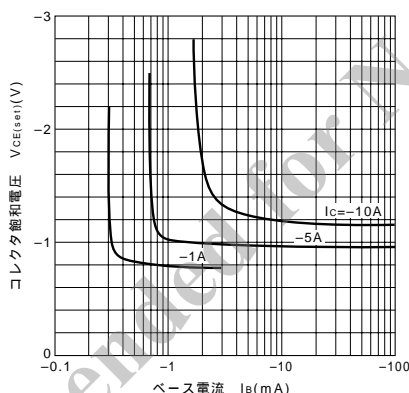

I_C-V_{BE}温度特性 (代表例)

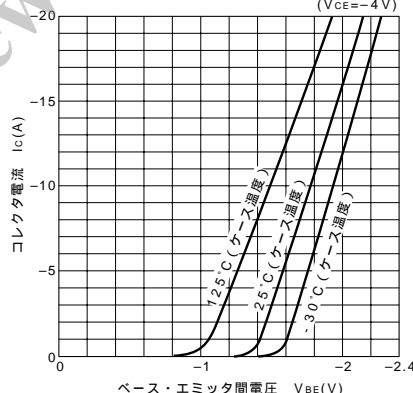

h_{FE}-I_C特性 (代表例)

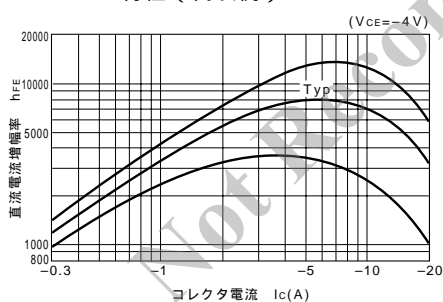

h_{FE}-I_C温度特性 (代表例)

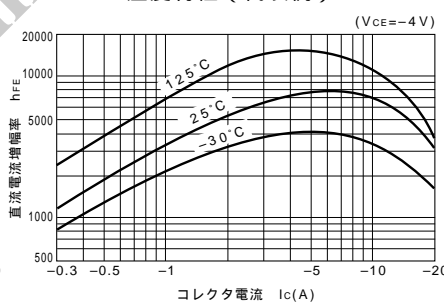

θ_{J-a}-t特性

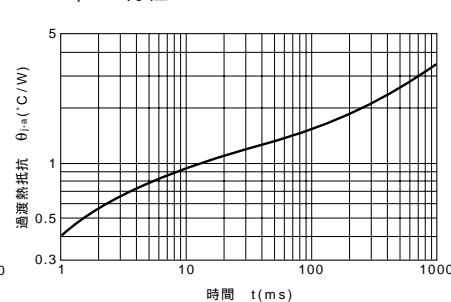

f_T-I_E特性 (代表例)

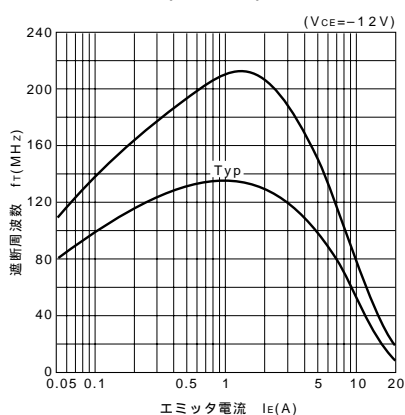

ASO曲線 (単発パルス)

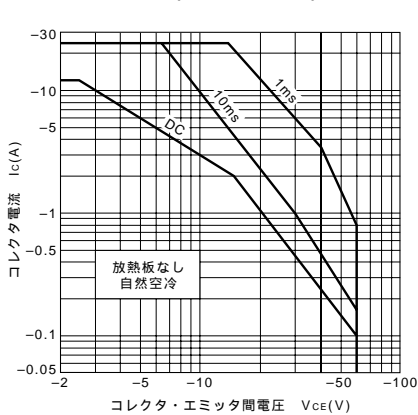

P_C-T_a定格

