

2SC3851/3851A

シリコンNPNエピタキシャルプレーナ型トランジスタ (2SA1488/1488Aとコンプリメンタリ)

用途: オーディオ、PPC高圧電源、一般用

絶対最大定格 (Ta=25)

記号	規格値		単位
	2SC3851	2SC3851A	
VcBo	80	100	V
VcEO	60	80	V
VEBO	6		V
Ic	4		A
Ib	1		A
Pc	25(Tc=25)		W
Tj	150		
Tstg	-55 ~ +150		

電気的特性 (Ta=25)

記号	試験条件	規格値		単位
		2SC3851	2SC3851A	
IcBo	VcB =	100max		μA
IcBo	VcB =	80	100	V
IcEO	VEB = 6V	100max		μA
V(BR)CEO	Ic = 25mA	60min	80min	V
hFE	VCE = 4V, Ic = 1A	40 ~ 320		
VCE(sat)	Ic = 2A, Ib = 0.2A	0.5max		V
fT	VCE = 12V, IE = -0.2A	15typ		MHz
COB	VcB = 10V, f = 1MHz	60typ		pF

外形図 FM20(TO220F)

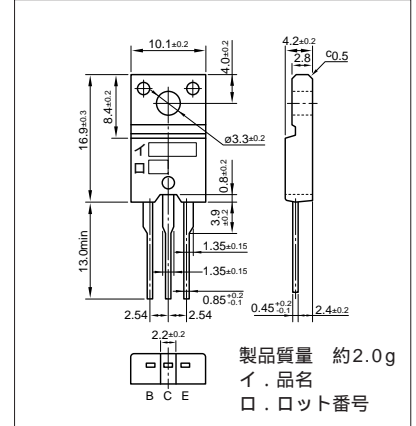

代表的スイッチング特性 (エミッタ接地)

Vcc (V)	RL (Ω)	Ic (A)	VBB1 (V)	VBB2 (V)	Ib1 (mA)	Ib2 (mA)	ton (μs)	tstg (μs)	tf (μs)
12	6	2	10	-5	200	-200	0.2typ	1typ	0.3typ

Ic-VCE特性 (代表例)

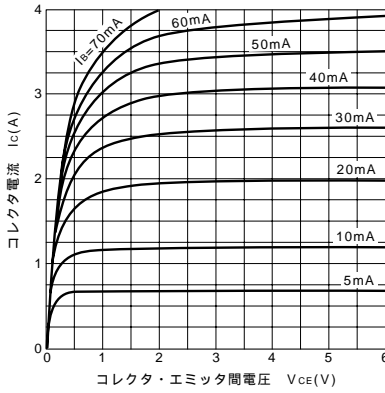

VCE(sat)-Ib特性 (代表例)

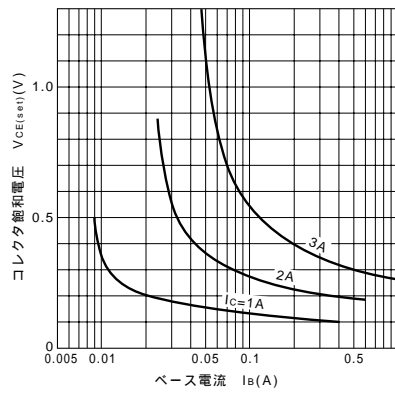

Ic-VBE温度特性 (代表例)

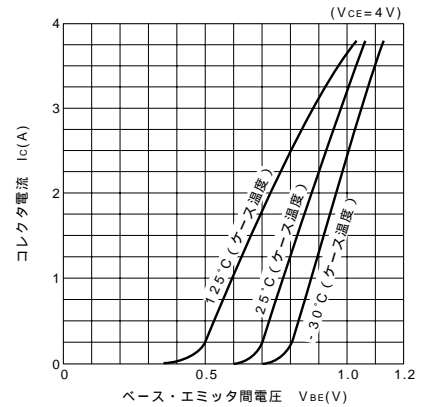

hFE-Ic特性 (代表例)

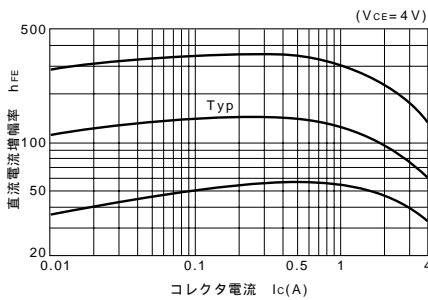

hFE-Ic温度特性 (代表例)

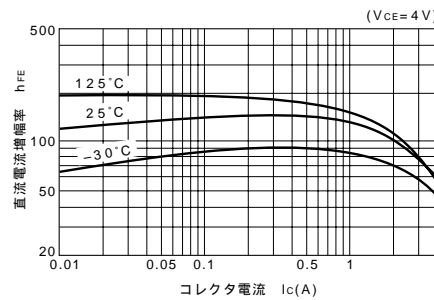

θja-t特性

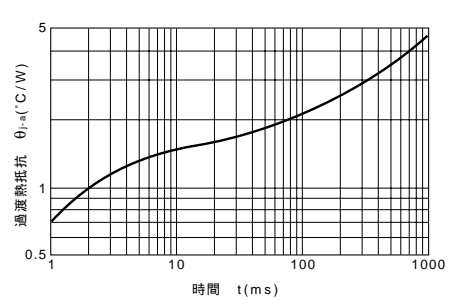

fT-IE特性 (代表例)

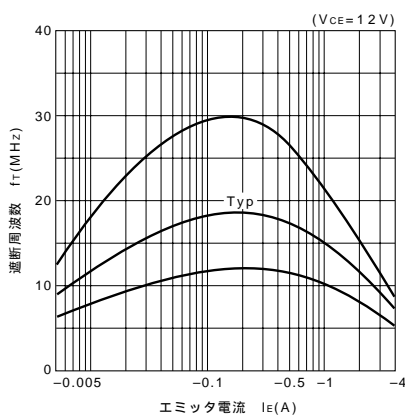

ASO曲線 (単発パルス)

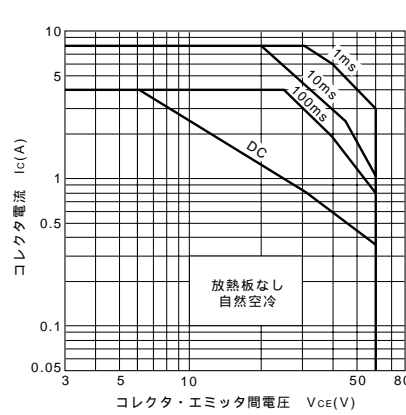

Pc-Ta定格

