

High hFE
LOW VCE (sat)

2SC3852/3852A

シリコンNPNエビタキシャルプレーナ型トランジスタ

用途：ソレノイド、モータ駆動、シリーズレギュレータ、一般用

絶対最大定格 (Ta=25)

電気的特性 (Ta=25)

(Ta=25)

外形図 FM20(TO220F)

記号	規格値		単位
	2SC3852	2SC3852A	
V _{CBO}	80	100	V
V _{CEO}	60	80	V
V _{EBO}	6		V
I _C	3		A
I _B	1		A
P _C	25(T _C =25)		W
T _J	150		
T _{stg}	-55 ~ +150		

記号	試験条件	規格値		単位
		2SC3852	2SC3852A	
I _{CBO}	V _{CB} =	10max		μA
I _{EBO}	V _{EB} = 6V	80	100	V
I _{EBO}		100max		μA
V _{(BR)CEO}	I _C = 25mA	60min	80min	V
h _{FE}	V _{CE} = 4V, I _C = 0.5A	500min		
V _{CE(sat)}	I _C = 2A, I _B = 50mA	0.5max		V
f _T	V _{CE} = 12V, I _E = -0.2A	15typ		MHz
COB	V _{CB} = 10V, f = 1MHz	50typ		pF

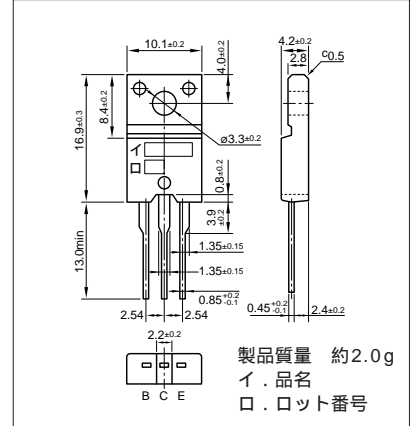

代表的スイッチング特性 (エミッタ接地)

V _{CC} (V)	R _L (Ω)	I _C (A)	V _{BB1} (V)	V _{BB2} (V)	I _{B1} (mA)	I _{B2} (mA)	t _{on} (μs)	t _{stg} (μs)	t _f (μs)
20	20	1.0	10	-5	15	-30	0.8typ	3.0typ	1.2typ

I_C-V_{CE}特性 (代表例)

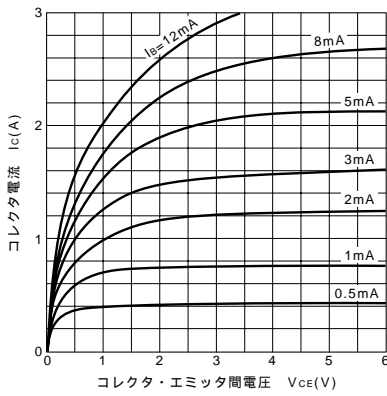

V_{CE(sat)}-I_B特性 (代表例)

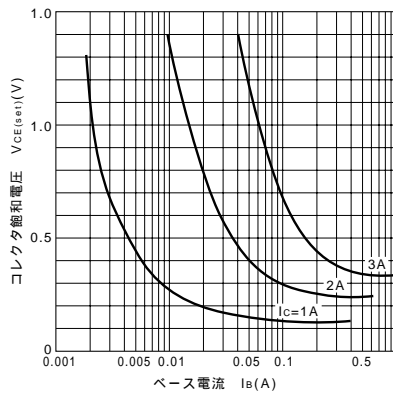

I_C-V_{BE}温度特性 (代表例)

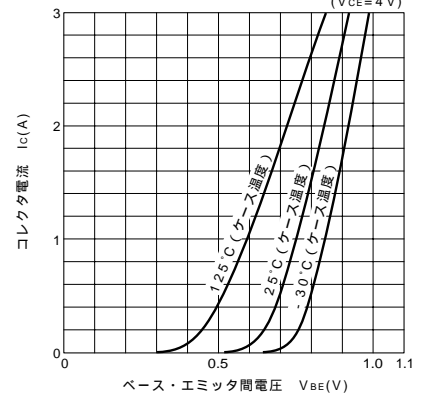

h_{FE}-I_C特性 (代表例)

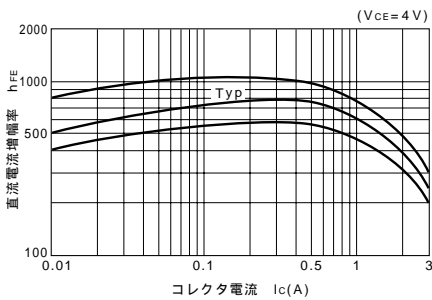

h_{FE}-I_C温度特性 (代表例)

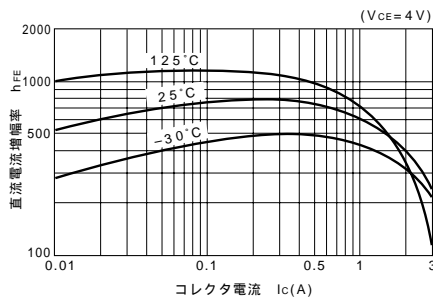

θ_{j-a}-t特性

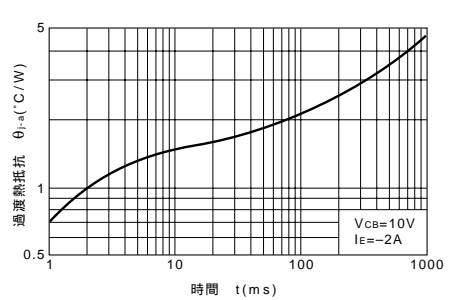

f_T-I_E特性 (代表例)

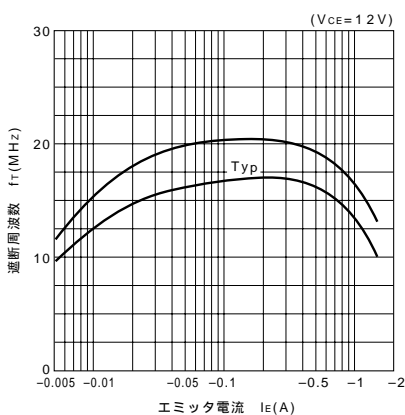

ASO曲線 (単発パルス)

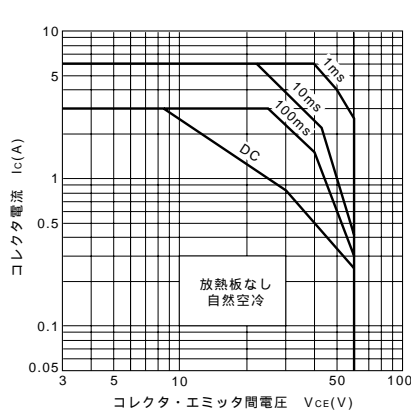

P_C-T_a定格

