

2SC3856

シリコンNPN三重拡散プレーナ型トランジスタ (2SA1492とコンプリメンタリ)

用途：オーディオ、一般用

絶対最大定格 (Ta=25)

記号	規格値	単位
V _{CB0}	200	V
V _{CEO}	180	V
V _{EB0}	6	V
I _C	15	A
I _B	4	A
P _C	130(T _C = 25)	W
T _j	150	
T _{stg}	-55 ~ +150	

電気的特性 (Ta=25)

記号	試験条件	規格値	単位
I _{CB0}	V _{CB} = 200V	100max	μA
I _{EB0}	V _{EB} = 6V	100max	μA
V(BR)CEO	I _C = 50mA	180min	V
h _{FE}	V _{CE} = 4V, I _C = 3A	50min	
V _{CE(sat)}	I _C = 5A, I _B = 0.5A	2.0max	V
f _r	V _{CE} = 12V, I _E = -0.5A	20typ	MHz
COB	V _{CB} = 10V, f = 1MHz	300typ	pF

ランク O(50~100), P(70~140), Y(90~180)

外形図 MT-100(TO3P)

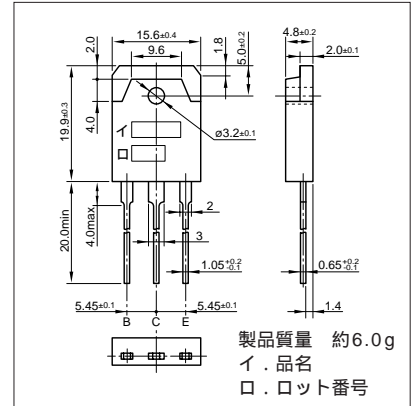

代表的スイッチング特性 (エミッタ接地)

V _{CC} (V)	R _L (Ω)	I _C (A)	V _{BB1} (V)	V _{BB2} (V)	I _{B1} (A)	I _{B2} (A)	t _{on} (μs)	t _{stg} (μs)	t _f (μs)
40	4	10	10	-5	1	-1	0.5typ	1.8typ	0.6typ

I_C-V_{CE}特性 (代表例)

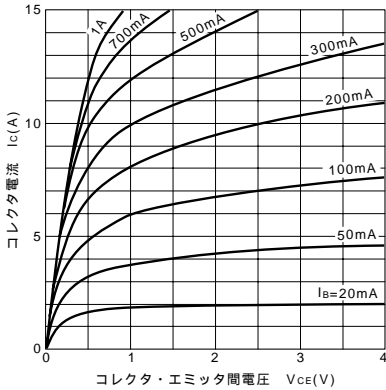

V_{CE(sat)}-I_B特性 (代表例)

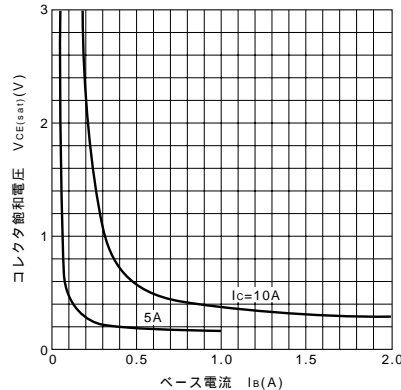

I_C-V_{BE}温度特性 (代表例)

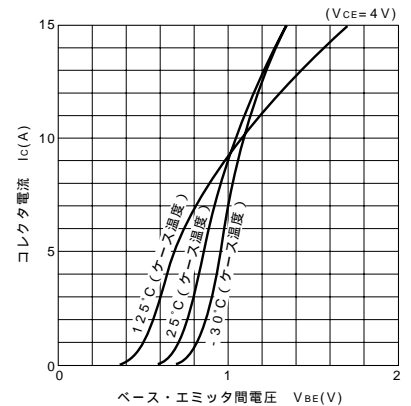

h_{FE}-I_C特性 (代表例)

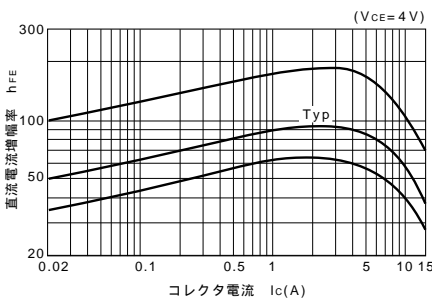

h_{FE}-I_C温度特性 (代表例)

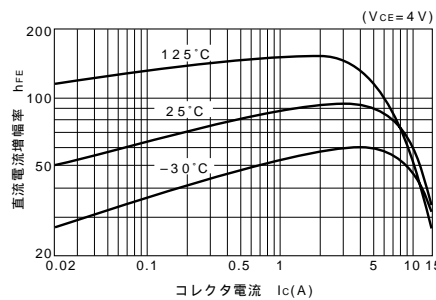

θ_{j-a}-t特性

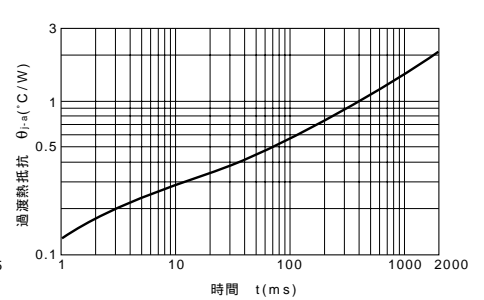

f_T-I_E特性 (代表例)

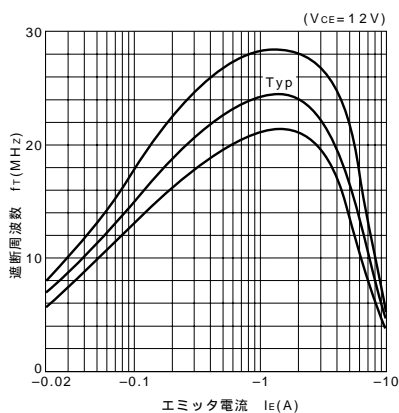

ASO曲線 (単発パルス)

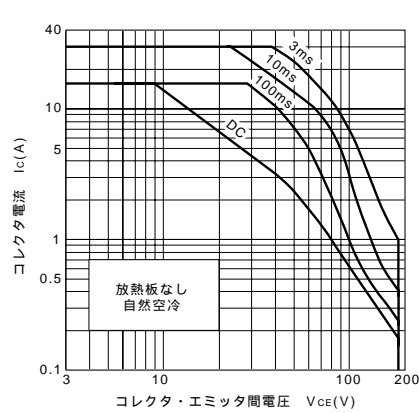

P_C-T_a定格

