

# 2SC4466

シリコンNPN三重拡散プレーナ型トランジスタ (2SA1693とコンプリメンタリ)

用途：オーディオ、一般用

## 絶対最大定格 (Ta = 25 )

記号	規格値	単位
V <sub>CB0</sub>	120	V
V <sub>CEO</sub>	80	V
V <sub>EBO</sub>	6	V
I <sub>C</sub>	6	A
I <sub>B</sub>	3	A
P <sub>C</sub>	60(T <sub>C</sub> = 25 )	W
T <sub>J</sub>	150	
T <sub>stg</sub>	-55 ~ +150	

## 電気的特性 (Ta = 25 )

記号	試験条件	規格値	単位
I <sub>CB0</sub>	V <sub>CB</sub> = 120V	10max	μA
I <sub>EBO</sub>	V <sub>EB</sub> = 6V	10max	μA
V(BR) <sub>CEO</sub>	I <sub>C</sub> = 50mA	80min	V
h <sub>FE</sub>	V <sub>CE</sub> = 4V, I <sub>C</sub> = 2A	50min	
V <sub>CE(sat)</sub>	I <sub>C</sub> = 2A, I <sub>B</sub> = 0.2A	1.5max	V
f <sub>T</sub>	V <sub>CE</sub> = 12V, I <sub>E</sub> = -0.5A	20typ	MHz
COB	V <sub>CB</sub> = 10V, f = 1MHz	110typ	pF

ランク O(50 ~ 100), P(70 ~ 140), Y(90 ~ 180)

## 外形図 MT-100(TO3P)

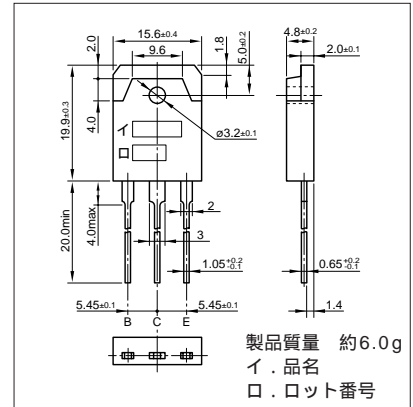

## 代表的スイッチング特性 (エミッタ接地)

V <sub>CC</sub> (V)	R <sub>L</sub> (Ω)	I <sub>C</sub> (A)	V <sub>BB1</sub> (V)	V <sub>BB2</sub> (V)	I <sub>B1</sub> (A)	I <sub>B2</sub> (A)	t <sub>on</sub> (μs)	t <sub>stg</sub> (μs)	t <sub>f</sub> (μs)
30	10	3	10	-5	0.3	-0.3	0.16typ	2.60typ	0.34typ

I<sub>C</sub>-V<sub>CE</sub>特性 (代表例)

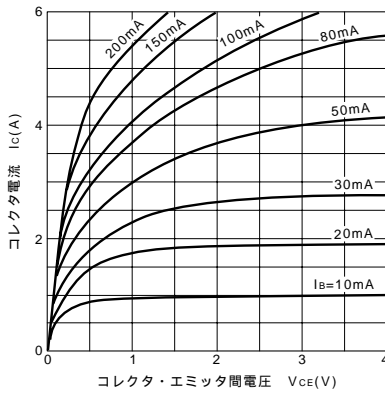

V<sub>CE(sat)</sub>-I<sub>B</sub>特性 (代表例)

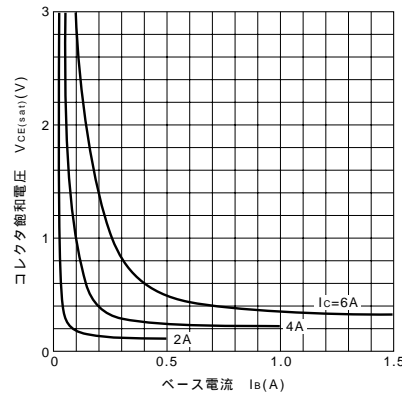

I<sub>C</sub>-V<sub>BE</sub>温度特性 (代表例)

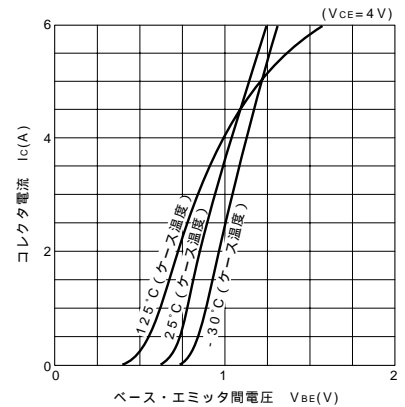

h<sub>FE</sub>-I<sub>C</sub>特性 (代表例)

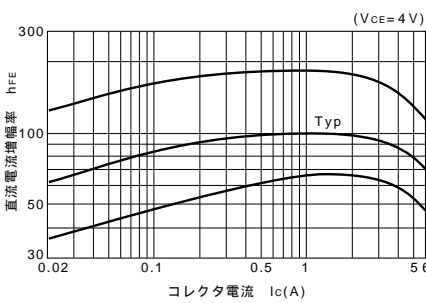

h<sub>FE</sub>-I<sub>C</sub>温度特性 (代表例)

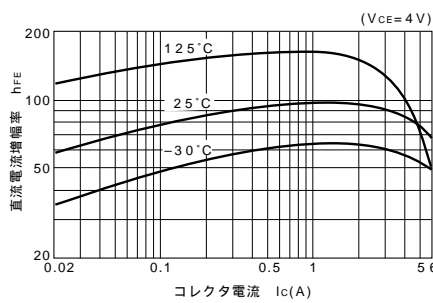

θ<sub>j-a</sub>-t特性

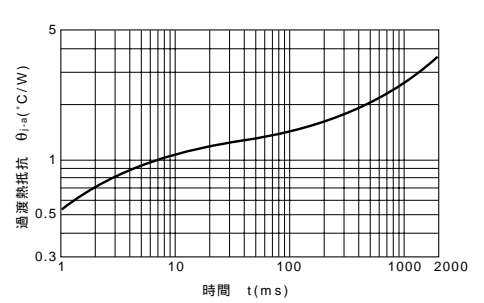

f<sub>T</sub>-I<sub>E</sub>特性 (代表例)

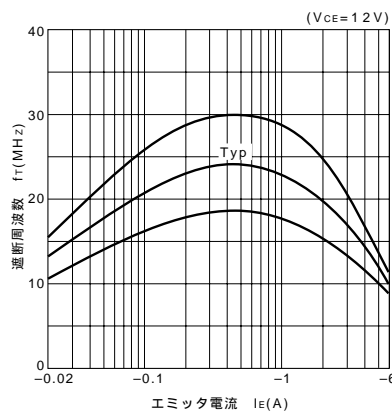

ASO曲線 (単発パルス)

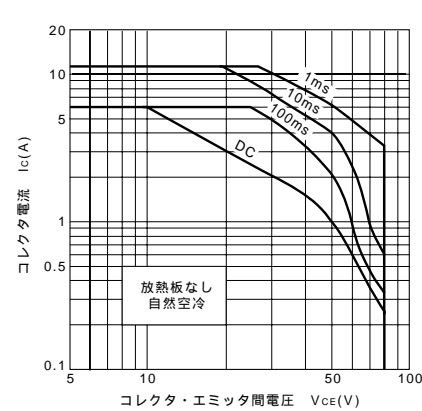

P<sub>C</sub>-T<sub>a</sub>定格

