

2SC4883/4883A

シリコンNPNエピタキシャルプレーナ型トランジスタ (2SA1859/1859Aとコンプリメンタリ)

用途：オーディオ出力ドライバ、TV速度変調

絶対最大定格 (Ta=25)

電気的特性 (Ta=25)

記号	規格値		単位
	2SC4883	2SC4883A	
VcBO	150	180	V
VCE0	150	180	V
VEBO	6		V
Ic	2		A
Ib	1		A
Pc	20(Tc=25)		W
Tj	150		
Tstg	- 55 ~ + 150		

記号	試験条件	規格値		単位
		2SC4883	2SC4883A	
IcBO	Vcb =	150	180	μA
IEBO	VEB = 6V	10max		μA
V(BR)CEO	Ic = 10mA	150min	180min	V
hFE	VCE = 10V, Ic = 0.7A	60 ~ 240		
VCE(sat)	Ic = 0.7A, Ib = 70mA	1.0max		V
fr	VCE = 12V, IE = - 0.7A	120typ		MHz
COB	Vcb = 10V, f = 1MHz	30typ		pF

外形図 FM20 (TO220F)

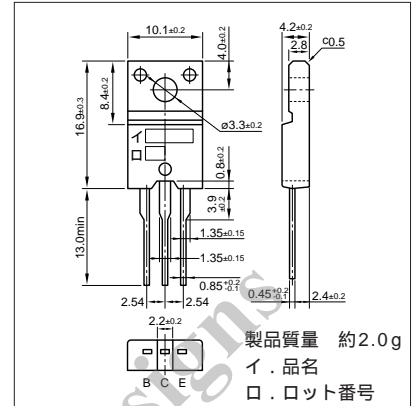

代表的スイッチング特性 (エミッタ接地)

VCC (V)	RL (Ω)	Ic (A)	VBB1 (V)	VBB2 (V)	Ib1 (mA)	Ib2 (mA)	ton (μs)	tstg (μs)	tf (μs)
20	20	1	10	-5	100	-100	0.5typ	1.5typ	0.5typ

Ic-VCE特性 (代表例)

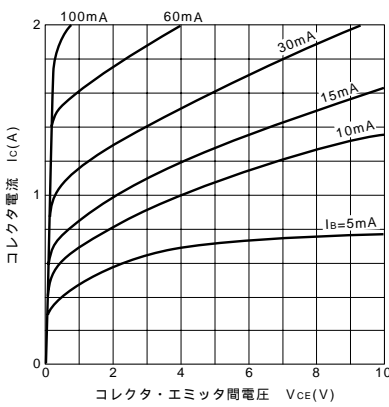

VCE(sat)-Ib特性 (代表例)

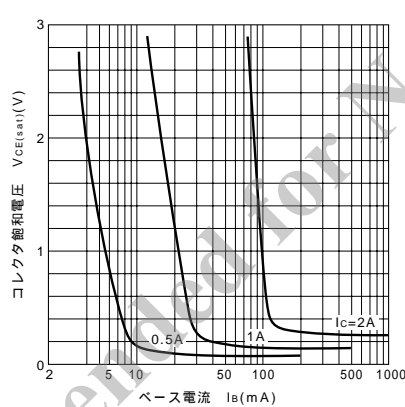

Ic-VBE温度特性 (代表例)

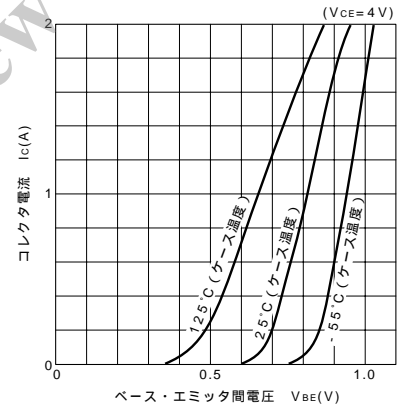

hFE-Ic特性 (代表例)

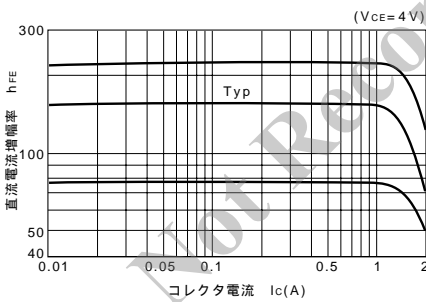

hFE-Ic温度特性 (代表例)

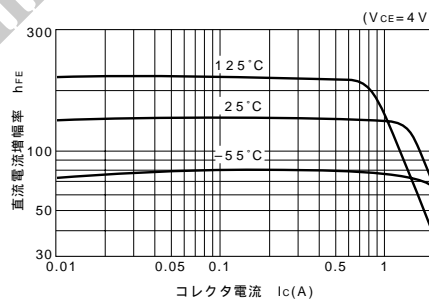

θj-a-t特性

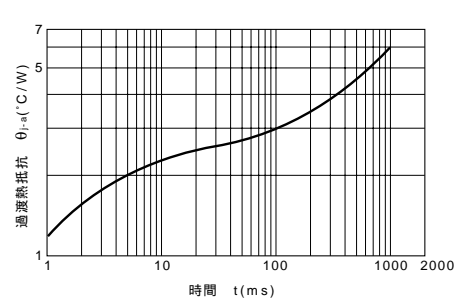

fT-IE特性 (代表例)

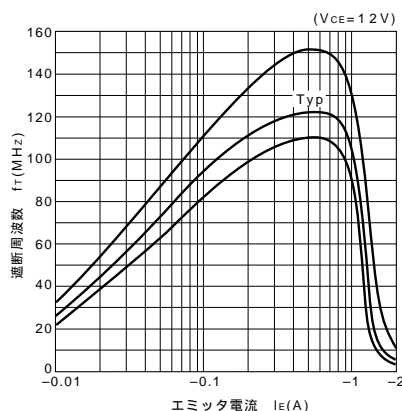

ASO曲線 (単発パルス)

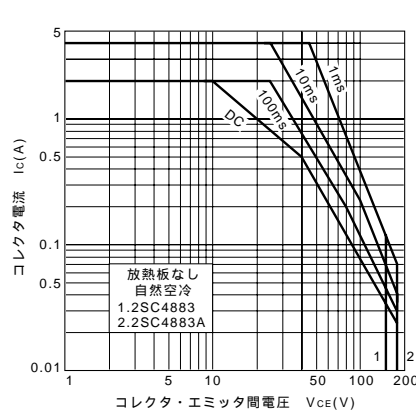

Pc-Ta定格

