

ダーリントン 2SD2561

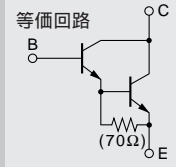

シリコン三重拡散プレーナ型トランジスタ(2SB1648とコンプリメンタリ)

用途：オーディオ、シリーズレギュレータ、一般用

絶対最大定格 (Ta = 25)

記号	規格値	単位
V _{CB0}	150	V
V _{CE0}	150	V
V _{EB0}	5	V
I _c	17	A
I _B	1	A
P _c	200(T _c = 25)	W
T _j	150	
T _{stg}	- 55 ~ + 150	

電気的特性 (Ta = 25)

記号	試験条件	規格値	単位
I _{CB0}	V _{CB} = 150V	100max	μA
I _{EB0}	V _{EB} = 5V	100max	μA
V(BR)CE0	I _c = 30mA	150min	V
h _{FE}	V _{CE} = 4V, I _c = 10A	5000min	
V _{CE(sat)}	I _c = 10A, I _B = 10mA	2.5max	V
V _{BE(sat)}	I _c = 10A, I _B = 10mA	3.0max	V
f _r	V _{CE} = 12V, I _E = - 2A	70typ	MHz
C _{OB}	V _{CB} = 10V, f = 1MHz	120typ	pF

外形図 MT-200

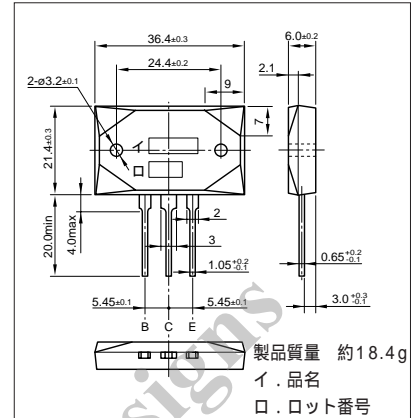

代表的スイッチング特性 (エミッタ接地)

V _{CC} (V)	R _L (Ω)	I _c (A)	V _{BB1} (V)	V _{BB2} (V)	I _{B1} (mA)	I _{B2} (mA)	t _{on} (μs)	t _{stg} (μs)	t _f (μs)
40	4	10	10	-5	10	-10	0.8typ	4.0typ	1.2typ

I_c-V_{CE}特性 (代表例)

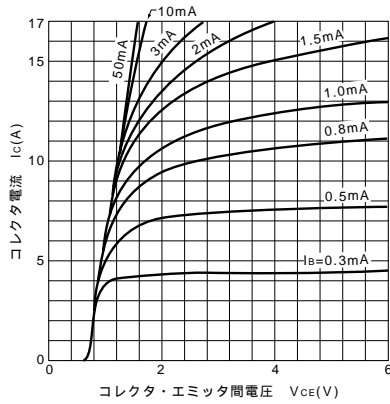

V_{CE(sat)}-I_B特性 (代表例)

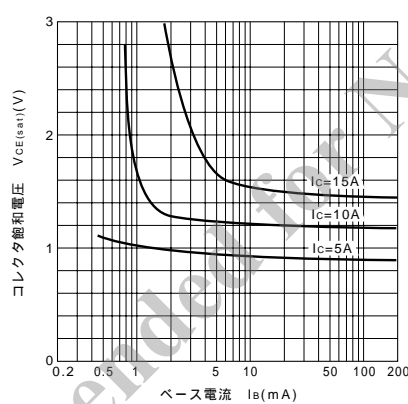

I_c-V_{BE}温度特性 (代表例)

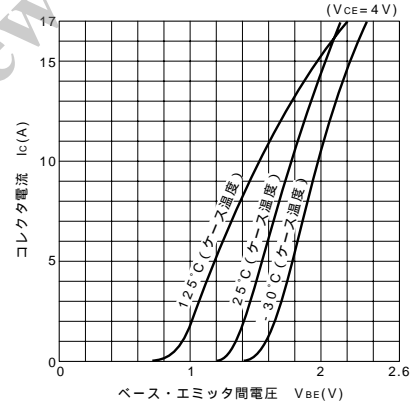

h_{FE}-I_c特性 (代表例)

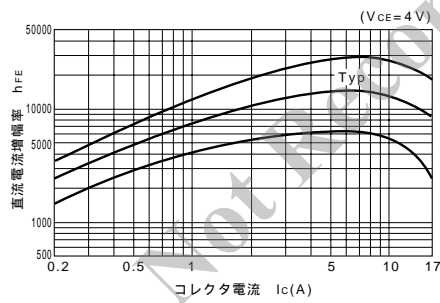

h_{FE}-I_c温度特性 (代表例)

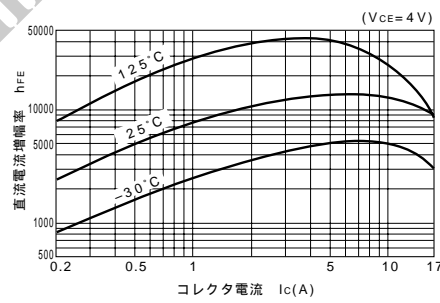

θ_{j-a}-t特性

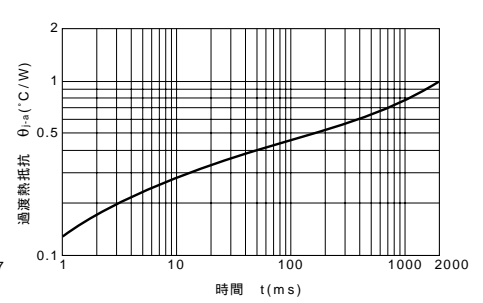

f_T-I_E特性 (代表例)

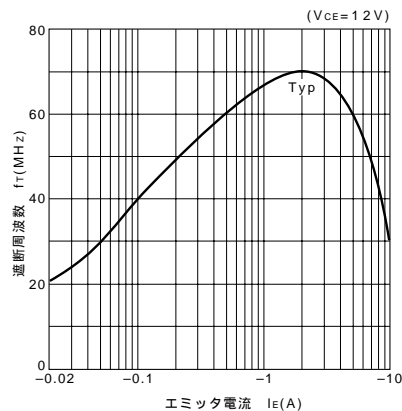

ASO曲線 (単発パルス)

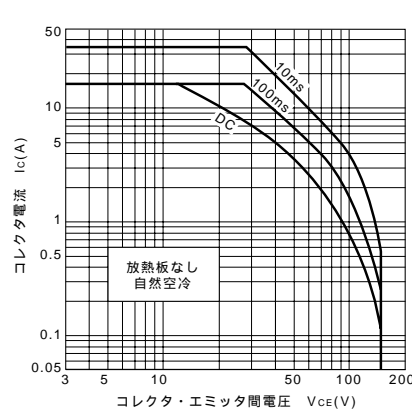

P_c-T_a定格

