

# MOS FET 2SK3801

## 絶対最大定格

(Ta=25°C)

記号	規格値	単位
V <sub>DSS</sub>	40	V
V <sub>GSS</sub>	±20	V
I <sub>D</sub>	±70	A
I <sub>D(pulse)</sub> <sup>※1</sup>	±140	A
P <sub>D</sub>	100 (T <sub>C</sub> =25°C)	W
EAS <sup>※2</sup>	400	mJ
T <sub>ch</sub>	150	°C
T <sub>stg</sub>	-40~+150	°C

※1: P<sub>w</sub> ≤ 100μs, duty cycle ≤ 1%

※2: V<sub>DD</sub>=20V, L=1mH, I<sub>L</sub>=20A, unclamped, R<sub>G</sub>=50Ω

## 電気的特性

(Ta=25°C)

記号	試験条件	規格値			単位
		min	typ	max	
V <sub>(BR)DSS</sub>	I <sub>D</sub> =100μA, V <sub>GS</sub> =0V	40			V
I <sub>GSS</sub>	V <sub>GS</sub> =±15V			±10	μA
I <sub>DSS</sub>	V <sub>DS</sub> =40V, V <sub>GS</sub> =0V			100	μA
V <sub>TH</sub>	V <sub>DS</sub> =10V, I <sub>D</sub> =1mA	2.0	3.0	4.0	V
R <sub>e(yfs)</sub>	V <sub>DS</sub> =10V, I <sub>D</sub> =35A	30	50		S
R <sub>DS(ON)</sub>	V <sub>GS</sub> =10V, I <sub>D</sub> =35A		5.0	6.0	mΩ
C <sub>iss</sub>	V <sub>DS</sub> =10V		5100		pF
C <sub>oss</sub>	f=1.0MHz		1200		pF
C <sub>rss</sub>	V <sub>GS</sub> =0V		860		pF
t <sub>d(on)</sub>	I <sub>D</sub> =35A		100		ns
t <sub>r</sub>	V <sub>DD</sub> =20V, R <sub>G</sub> =22Ω		100		ns
t <sub>d(off)</sub>	R <sub>L</sub> =0.57Ω, V <sub>GS</sub> =10V		300		ns
t <sub>f</sub>			130		ns
V <sub>SD</sub>	I <sub>SD</sub> =50A, V <sub>GS</sub> =0V		0.9	1.5	V
t <sub>rr</sub>	I <sub>SD</sub> =25A, di/dt=50A/μs		100		ns
R <sub>th(ch-c)</sub>				1.25	°C/W
R <sub>th(ch-a)</sub>				35.71	°C/W

## 外形図 TO-3P

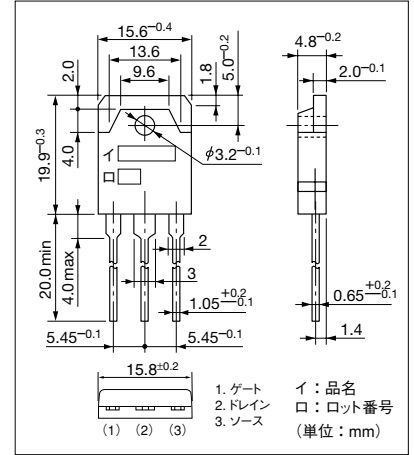

### ■ I<sub>D</sub>-V<sub>DS</sub> 特性 (代表例)

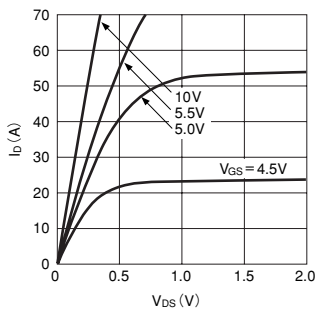

### ■ I<sub>D</sub>-V<sub>GS</sub> 特性 (代表例)

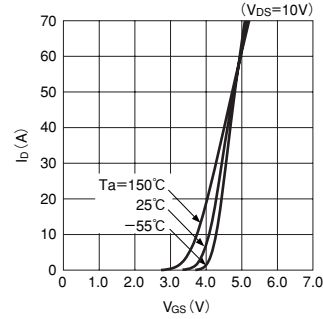

### ■ V<sub>DS</sub>-V<sub>GS</sub> 特性 (代表例)

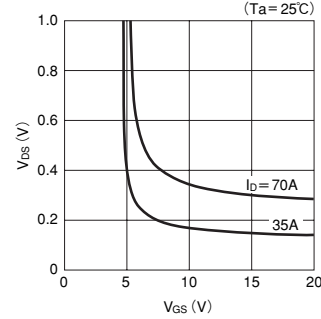

### ■ R<sub>e(yfs)</sub>-I<sub>D</sub> 特性 (代表例)

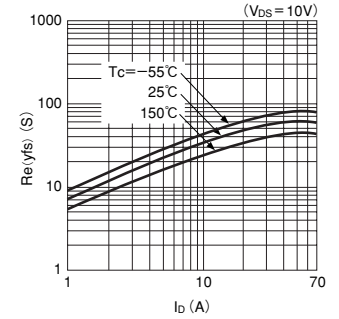

### ■ R<sub>DS(ON)</sub>-I<sub>D</sub> 特性 (代表例)

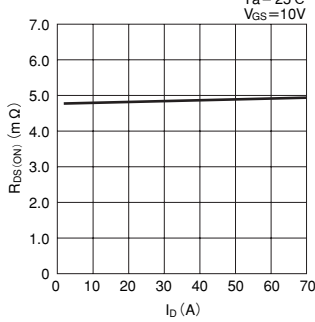

### ■ R<sub>DS(ON)</sub>-T<sub>C</sub> 特性 (代表例)

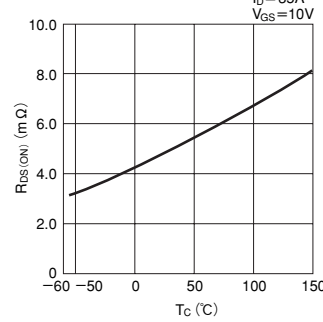

### ■ θ<sub>J-C</sub>-P<sub>w</sub> 特性 (単発パルス)

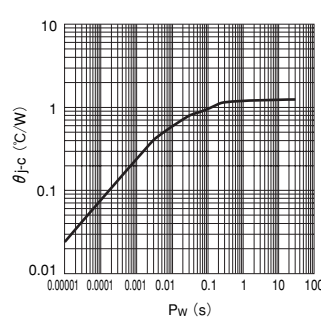

### ■ ダイナミック入出力特性 (代表例)

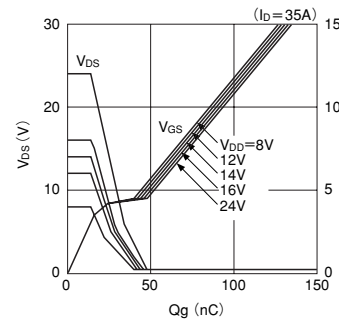

### ■ Capacitance-V<sub>DS</sub> 特性 (代表例)

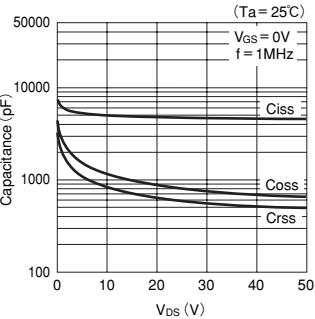

### ■ I<sub>DR</sub>-V<sub>SD</sub> 特性 (代表例)

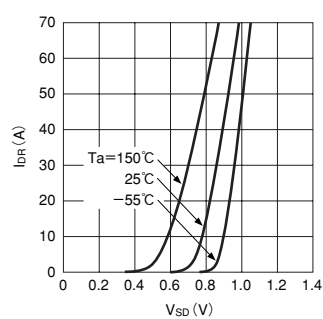

### ■ ASO 曲線 (単発パルス)

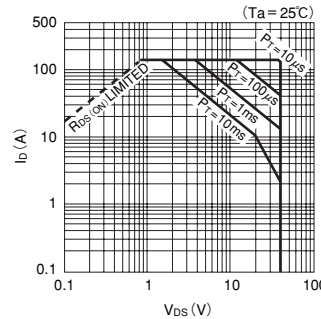

### ■ P<sub>D</sub>-T<sub>C</sub> 特性

