

C 4 5 0

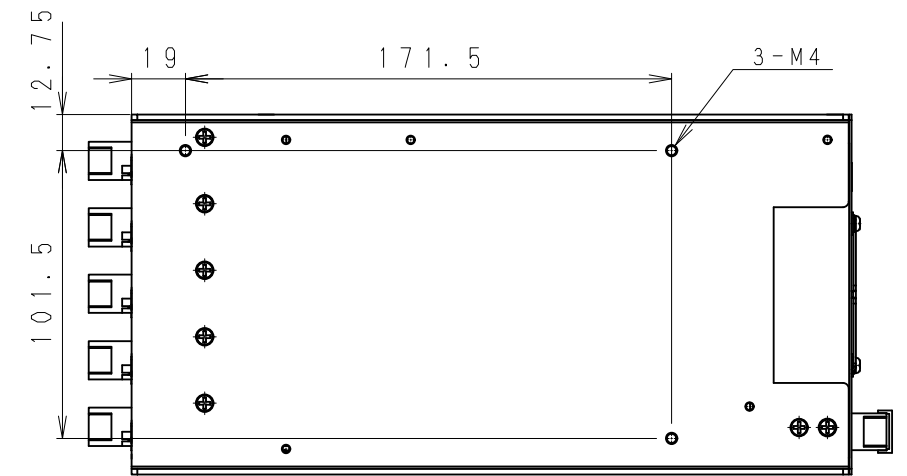
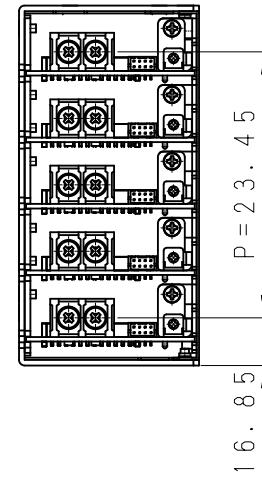
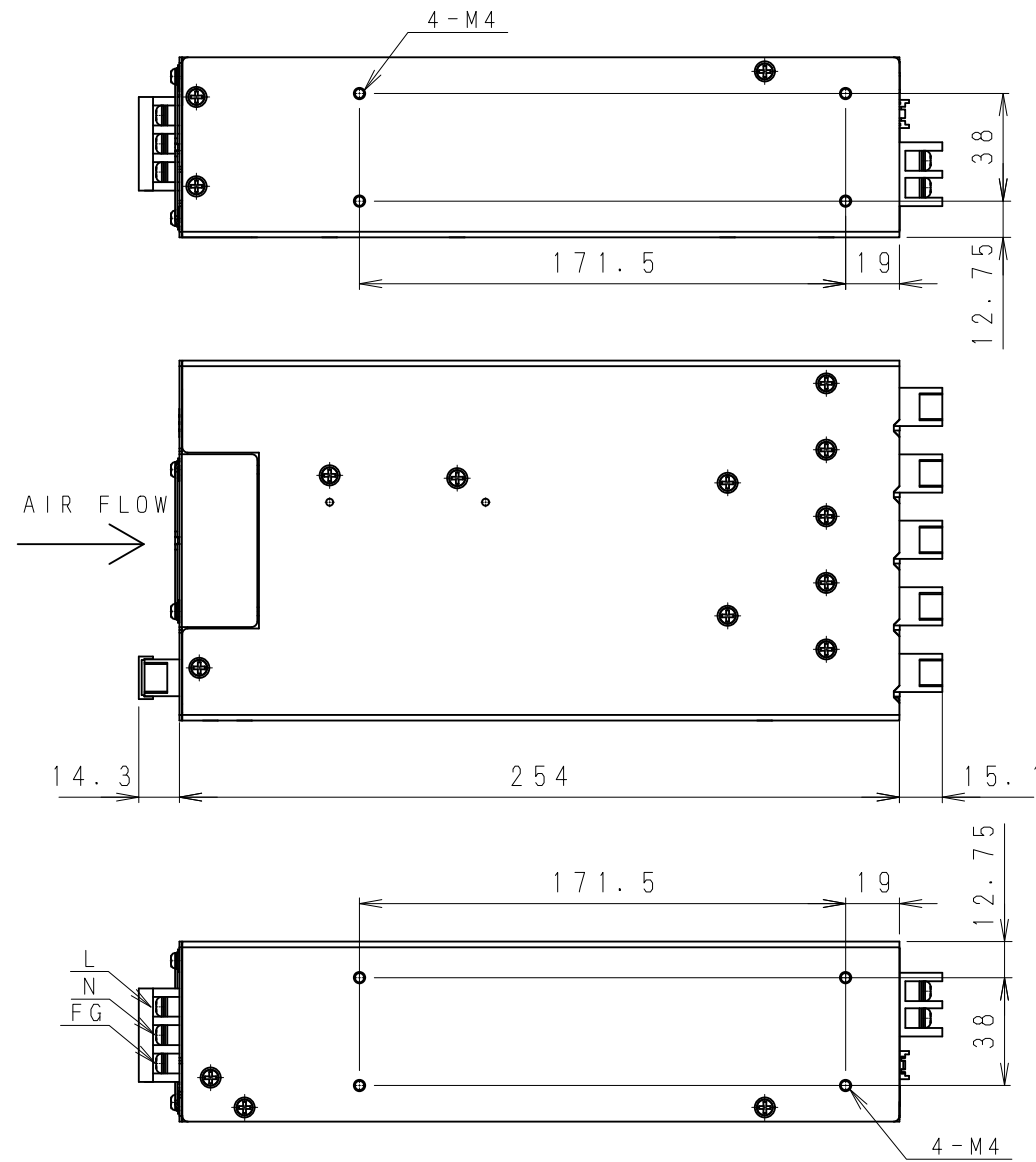
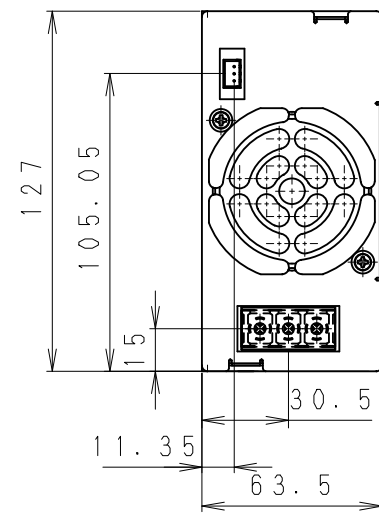

tolerance = ± 1.0 mm

Dimensions in mm