

V_Z = 27 V (typ.)
Automotive Alternator Diode
SG-C17xxZ27 Series

Description

The SG-C17xxZ27 series are the rectification diodes designed for alternator circuit of automotives, and have zener characteristics with high surge capability.

The package is the press-fit type that has high heat release capability and high reliability for high temperature and humidity environment. In addition, the bridge circuit can be configured easily in small area by using suffix “S” type and suffix “R” type of reverse polarity type.

Features

- T_J = 235 °C Capability Suitable for High Reliability and Automotive Requirement
- Thermal Fatigue Capability: 5,000 cyc.
- High Surge Capability
- RoHS Compliant

Applications

- Alternator Circuit for the 12 V Battery Automotive

Typical Application

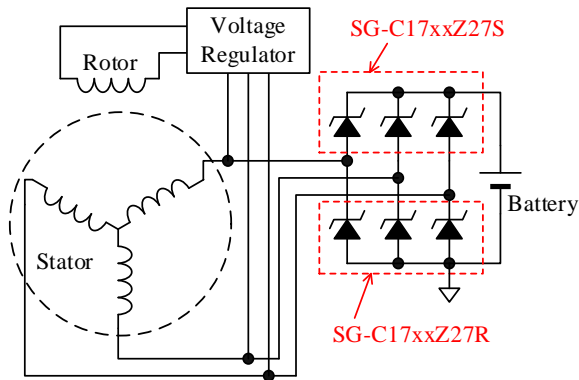

Package

Pressfit

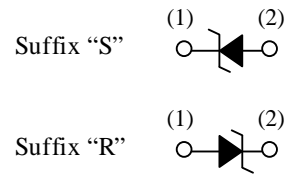
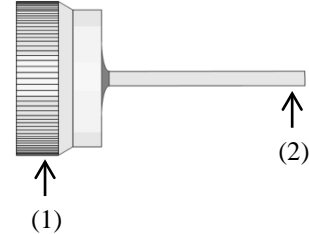

Not to scale

Pin No.	Suffix “S”	Suffix “R”
(1)	Cathode	Anode
(2)	Anode	Cathode

Selection Guide

Part Number	I _{F(AV)}	T _J (Max.)	V _Z	
			Min.	Max.
SG-C17LXZ27S	35 A	235 °C	24 V	30 V
SG-C17LXZ27R				
SG-C17VLZ27S	50 A			
SG-C17VLZ27R				
SG-C17VVZ27S	60 A			
SG-C17VVZ27R				
SG-C17WVZ27S	80 A			
SG-C17WVZ27R				

Contents

Description ----- 1
Contents ----- 2
Absolute Maximum Ratings ----- 3
Electrical Characteristics ----- 4
SG-C17LXZ27S, SG-C17LXZ27R Rating and Characteristic Curves ----- 5
SG-C17VLZ27S, SG-C17VLZ27R Rating and Characteristic Curves ----- 6
SG-C17VVZ27S, SG-C17VVZ27R Rating and Characteristic Curves ----- 8
SG-C17VWZ27S, SG-C17VWZ27R Rating and Characteristic Curves ----- 9
Physical Dimensions----- 11
Marking Diagram----- 13
Important Notes----- 14

Absolute Maximum Ratings

Unless otherwise specified, $T_A = 25\text{ }^\circ\text{C}$

Parameter	Symbol	Conditions	Rating	Unit	Remarks
Peak Reverse Voltage	V_{RM}		20	V	
Average Forward Current	$I_{F(AV)}$		35	A	SG-C17LXZ27S/R
			50		SG-C17VLZ27S/R
			60		SG-C17VVZ27S/R
			80		SG-C17WVZ27S/R
Surge Forward Current	I_{FSM}	Half cycle sine-wave, positive side, 10ms, one shot.	350	A	SG-C17LXZ27S/R
			500		SG-C17VLZ27S/R SG-C17VVZ27S/R
			600		SG-C17WVZ27S/R
Surge Reverse Voltage	V_{RSM}	One shot, See Figure 2.	50	V	SG-C17LXZ27S/R
			65		SG-C17VLZ27S/R
			75		SG-C17VVZ27S/R
			95		SG-C17WVZ27S/R
Junction Temperature	T_J		-40 to 235	$^\circ\text{C}$	
Case Temperature	T_C	See Figure 1.	-40 to 215	$^\circ\text{C}$	
Storage Temperature	T_{STG}		-40 to 215	$^\circ\text{C}$	

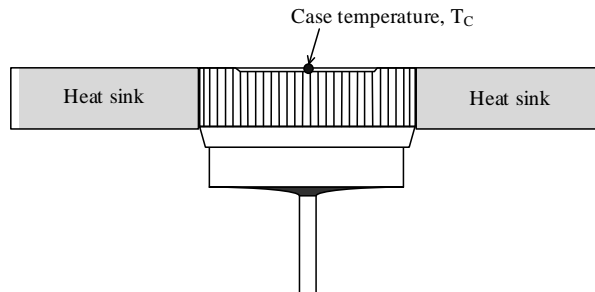

Figure 1. Lead Temperature Measurement Conditions

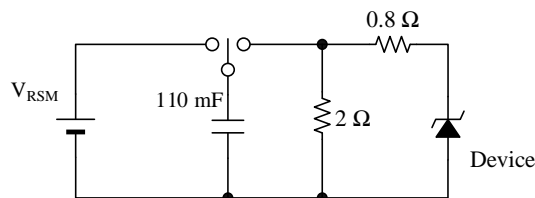

Figure 2. Surge Reverse Voltage Measurement Circuit (JASO A-1)

SG-C17xxZ27

Electrical Characteristics

Unless otherwise specified, $T_A = 25\text{ }^\circ\text{C}$

Parameter	Symbol	Conditions	Min.	Typ.	Max.	Unit	Remarks
Forward Voltage Drop	V_F	$I_F = 100\text{ A}$, $t = 5\text{ ms}$	—	—	1.25	V	SG-C17LXZ27S/R
			—	—	1.20		SG-C17VLZ27S/R
			—	—	1.15		SG-C17VVZ27S/R
			—	—	1.10		SG-C17WVZ27S/R
Reverse Leakage Current	I_R	$V_R = V_{RM}$	—	—	1	μA	
Breakdown Voltage	V_Z	$I_Z = 10\text{ mA}$	24	27	30	V	
Breakdown Voltage Temperature Coefficient	r_Z	$I_Z = 10\text{ mA}$	—	22	—	$\text{mV}/^\circ\text{C}$	
Thermal Resistance	$R_{th(j-c)}$	⁽¹⁾	—	—	0.6	$^\circ\text{C}/\text{W}$	SG-C17LXZ27S/R
			—	—	0.5		SG-C17VLZ27S/R
			—	—	0.4		SG-C17VVZ27S/R SG-C17WVZ27S/R

⁽¹⁾ $R_{th(j-c)}$ is thermal resistance between junction and case. Case temperature is measured as shown in Figure 1.

SG-C17LXZ27S, SG-C17LXZ27R Rating and Characteristic Curves

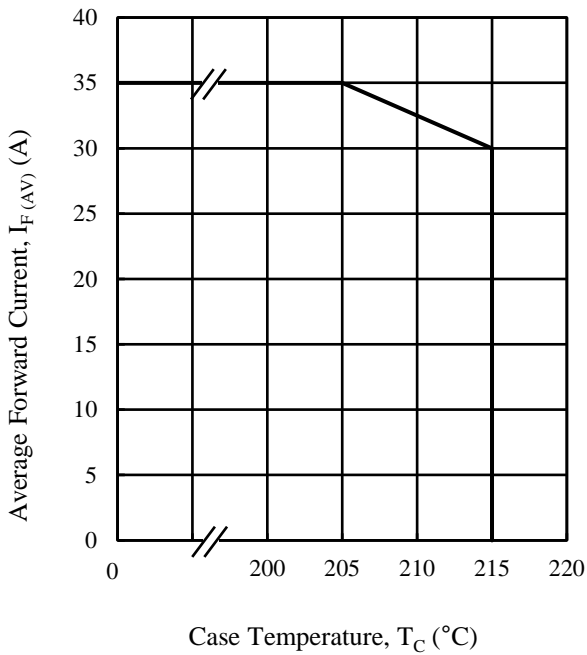

Figure 3. Power Dissipation Curves⁽²⁾

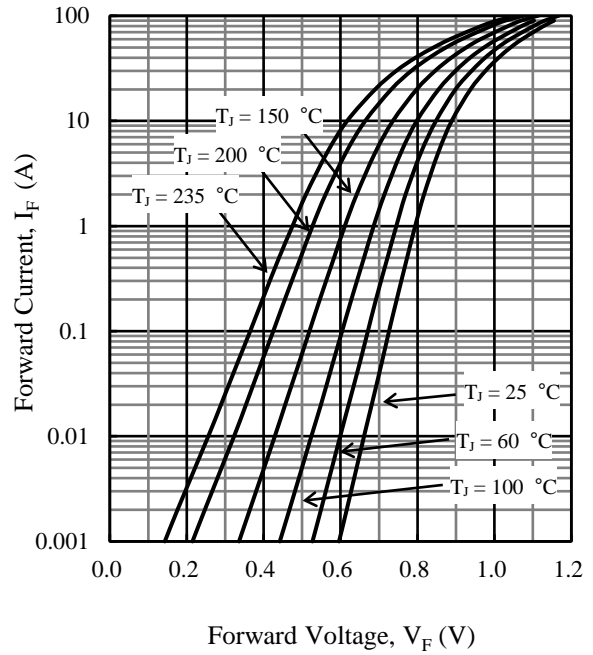

Figure 4. I_F vs. V_F Typical Characteristics

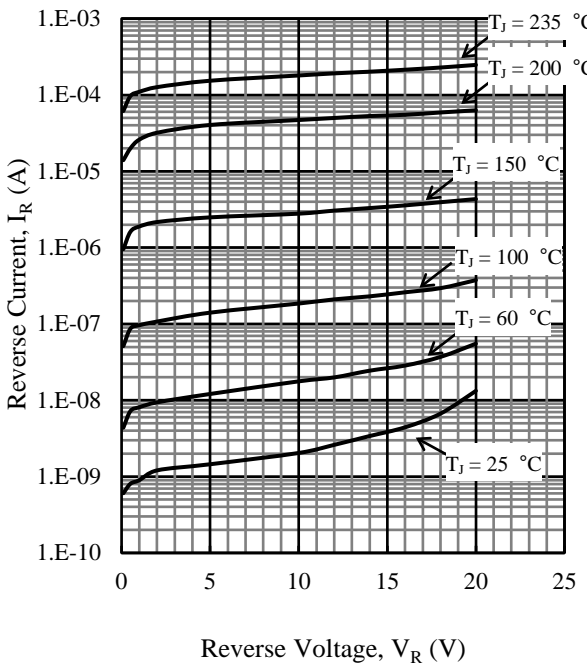

Figure 5. I_R vs. V_R Typical Characteristics

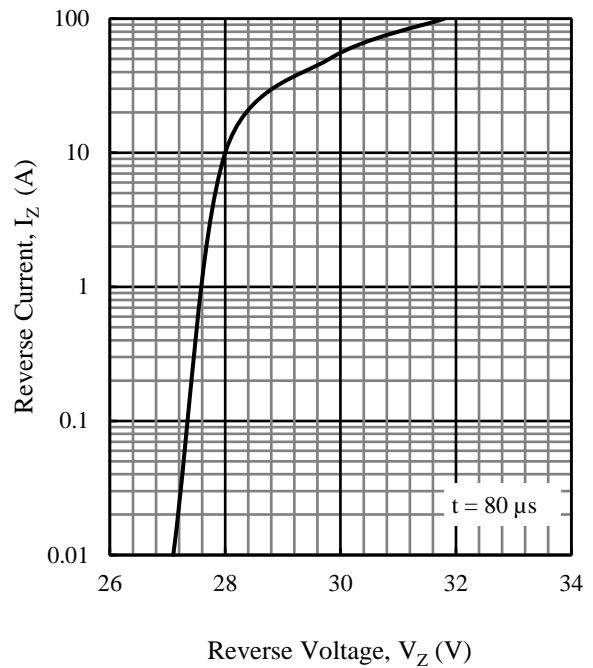

Figure 6. I_Z vs. V_Z Typical Characteristics

⁽²⁾ See Figure 1 for the measurement conditions of lead temperature.

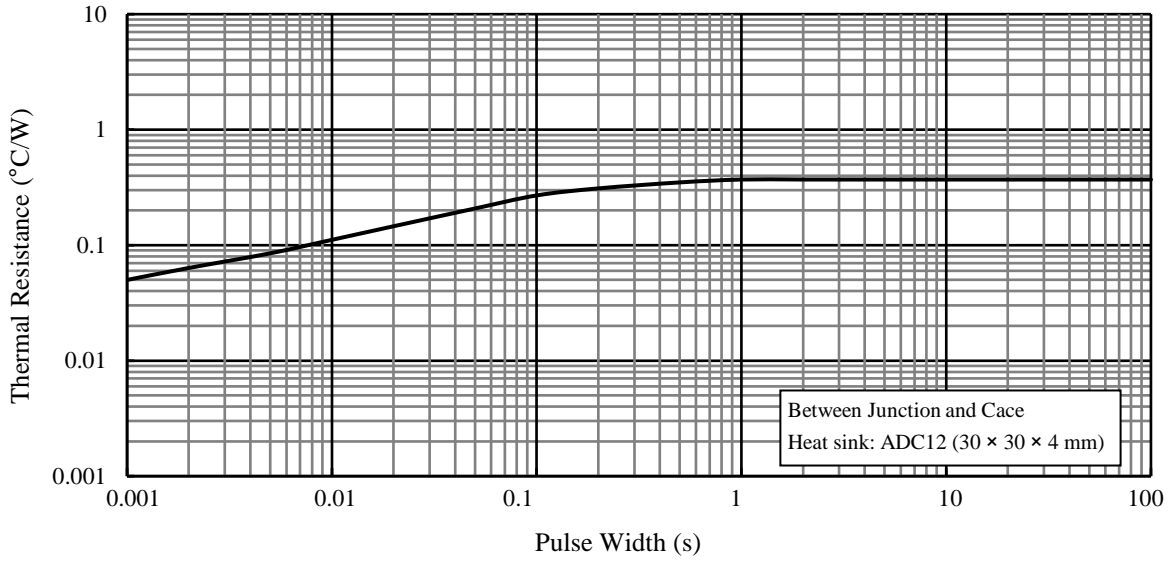

Figure 7. Typical Transient Thermal Resistance ⁽³⁾

SG-C17VLZ27S, SG-C17VLZ27R Rating and Characteristic Curves

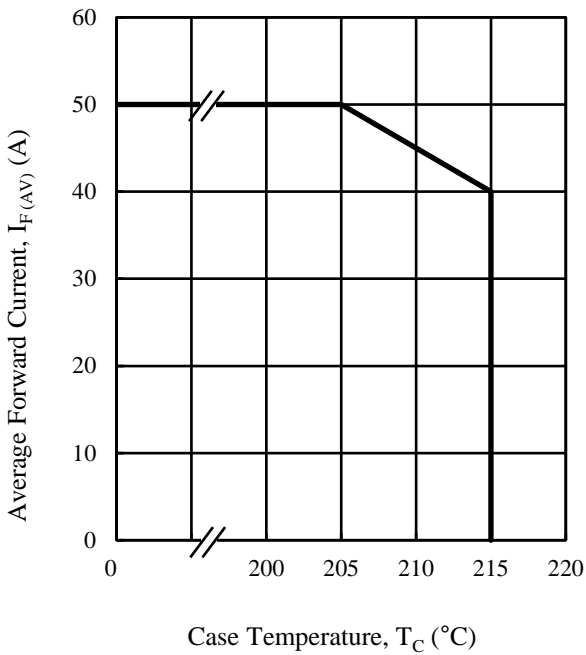

Figure 8. Power Dissipation Curves ⁽⁴⁾

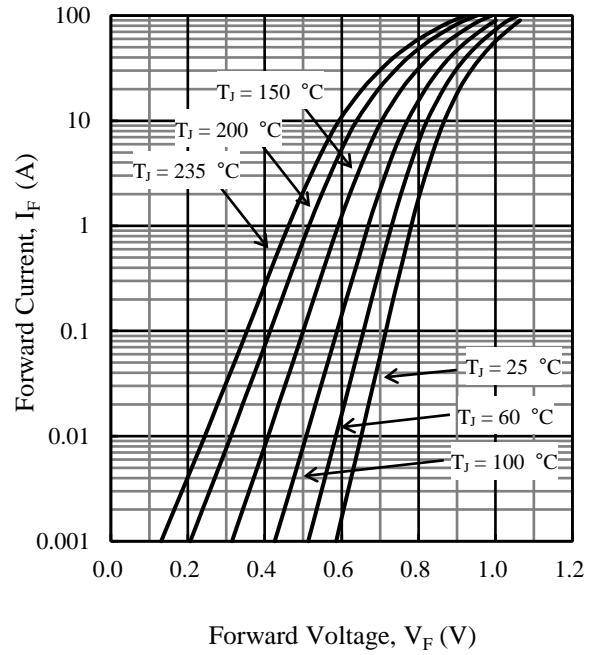

Figure 9. V_F vs. I_F Typical Characteristics

⁽³⁾ See Figure 1 for measurement conditions of lead temperature.
⁽⁴⁾ See Figure 1 for measurement conditions of lead temperature.

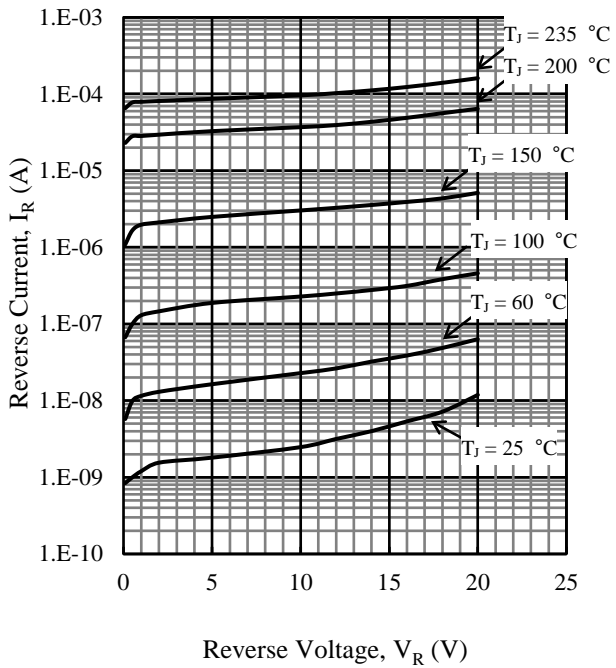

Figure 10. V_R vs. I_R Typical Characteristics

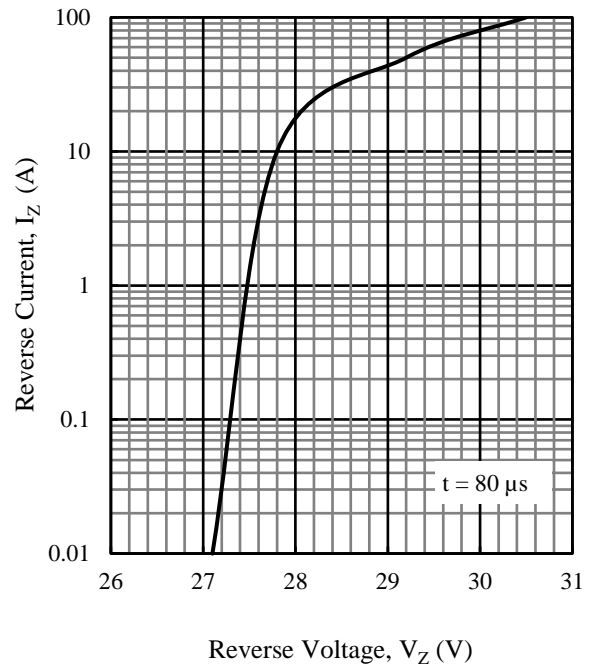

Figure 11. I_Z vs. V_Z Typical Characteristics

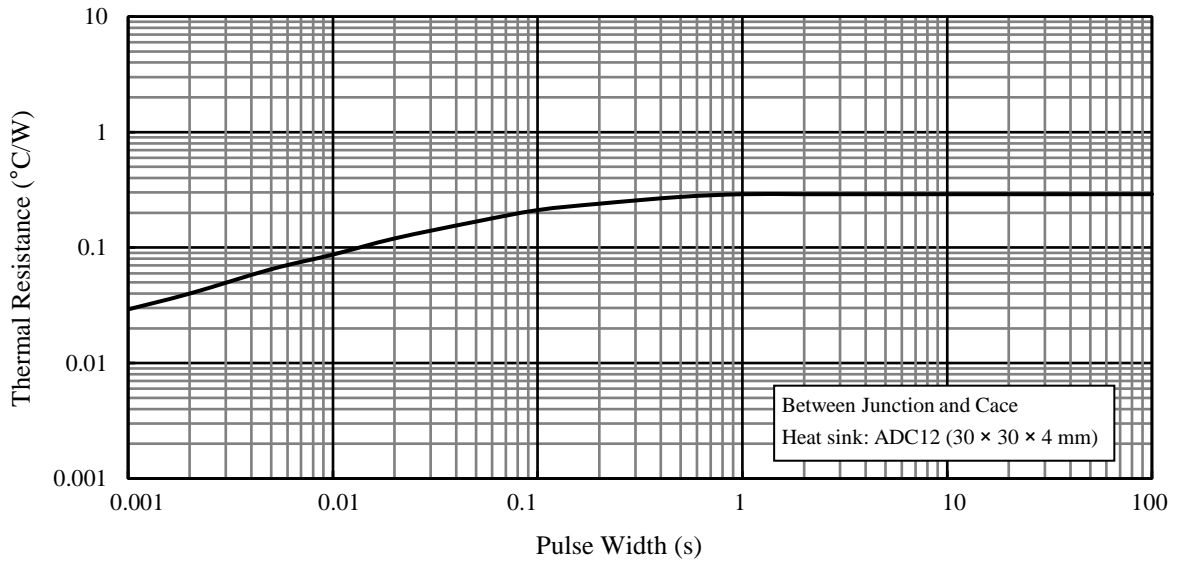

Figure 12. Typical Transient Thermal Resistance⁽⁵⁾

⁽⁵⁾ See Figure 1 for the measurement conditions of lead temperature.

SG-C17VVZ27S, SG-C17VVZ27R Rating and Characteristic Curves

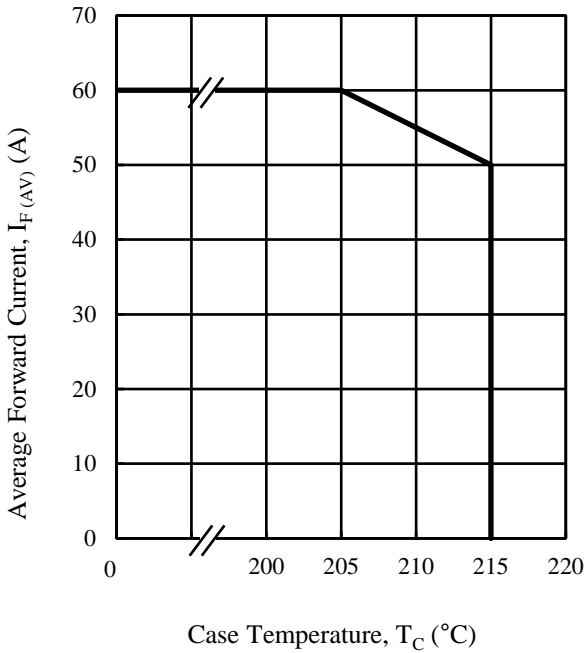

Figure 13. Power Dissipation Curves⁽⁶⁾

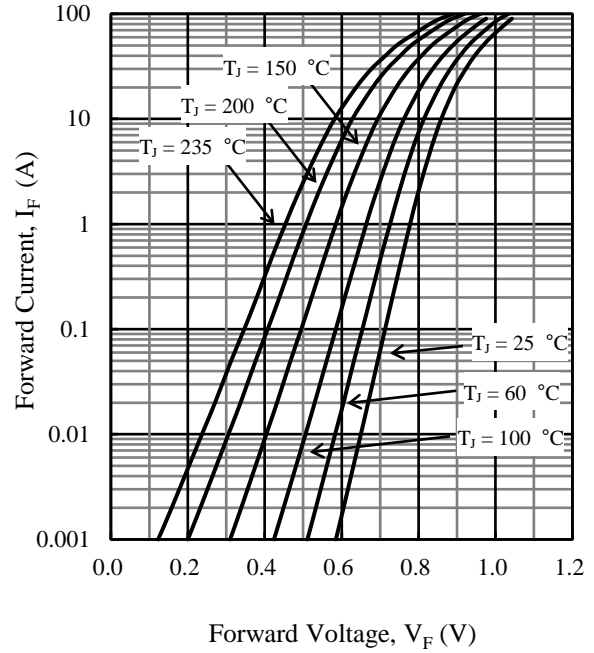

Figure 14. V_F vs. I_F Typical Characteristics

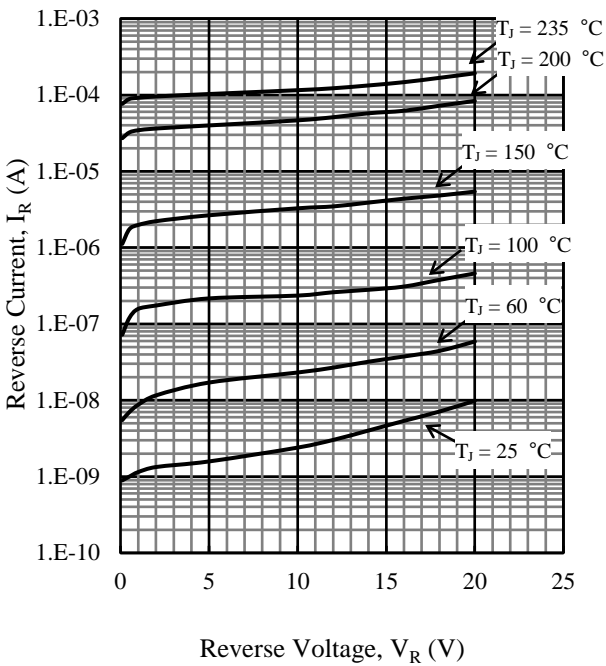

Figure 15. V_R vs. I_R Typical Characteristics

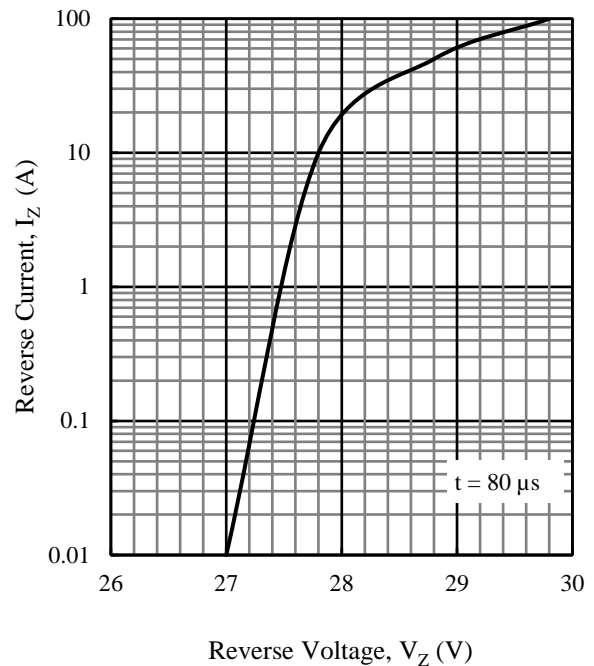

Figure 16. I_Z vs. V_Z Typical Characteristics

⁽⁶⁾ See Figure 1 for the measurement conditions of lead temperature.

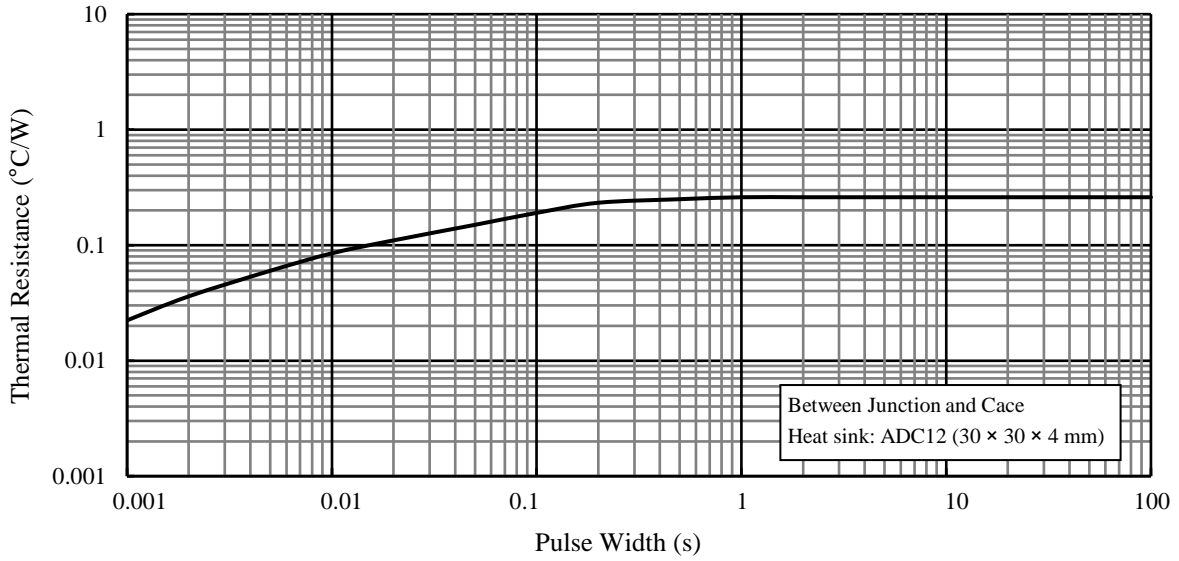

Figure 17. Typical Transient Thermal Resistance⁽⁷⁾

SG-C17VWZ27S, SG-C17VWZ27R Rating and Characteristic Curves

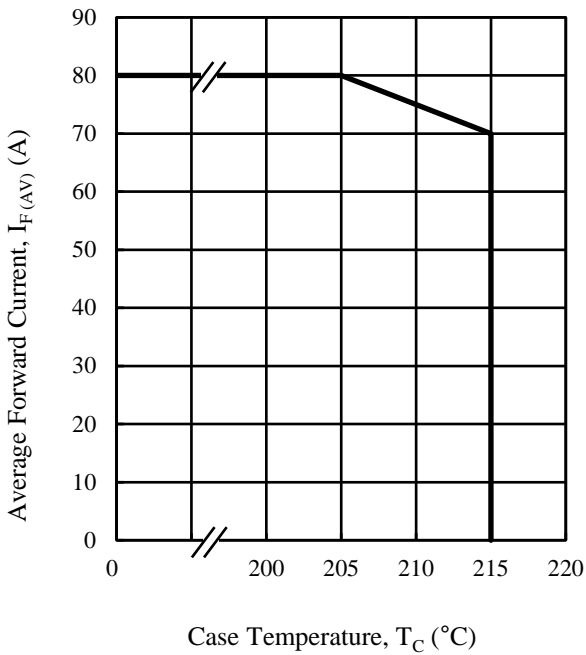

Figure 18. Power Dissipation Curves⁽⁸⁾

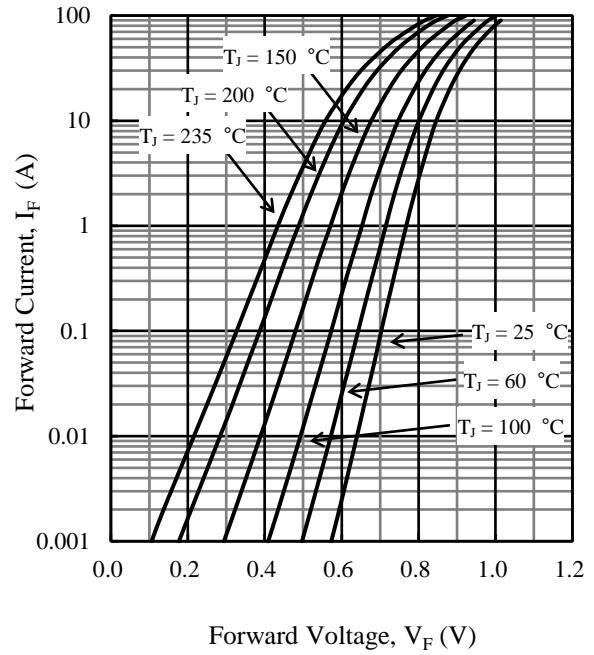

Figure 19. V_F vs. I_F Typical Characteristics

⁽⁷⁾ See Figure 1 for the measurement conditions of lead temperature.

⁽⁸⁾ See Figure 1 for the measurement conditions of lead temperature.

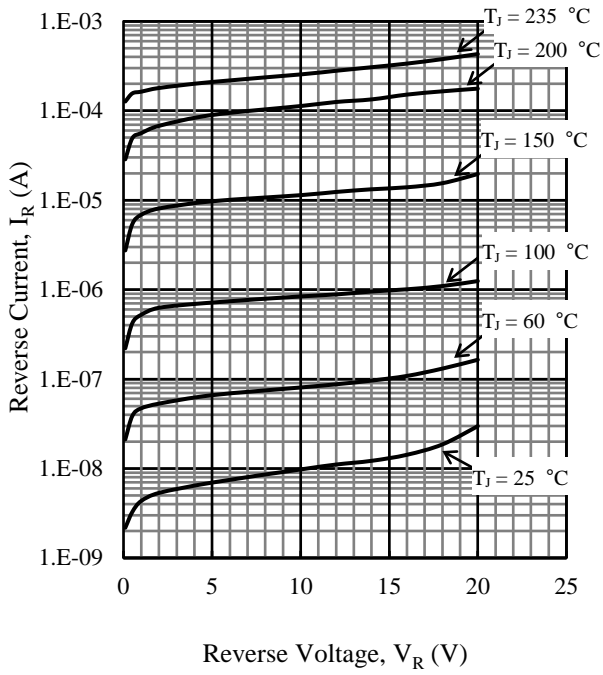

Figure 20. V_R vs. I_R Typical Characteristics

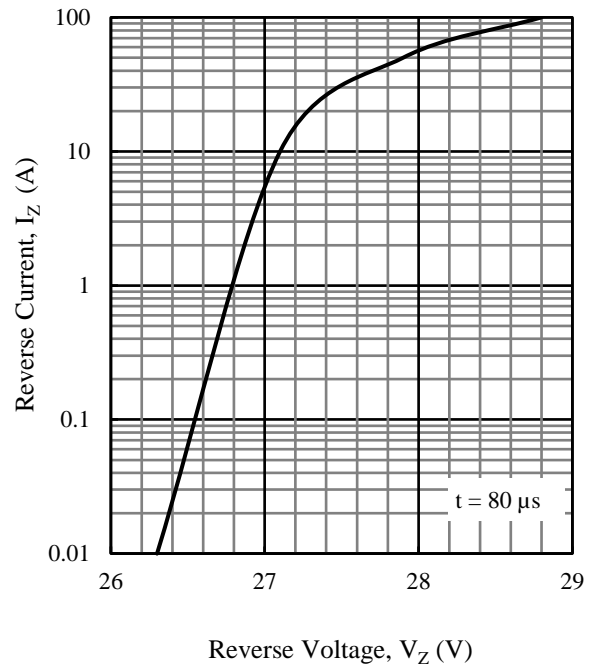

Figure 21. I_Z vs. V_Z Typical Characteristics

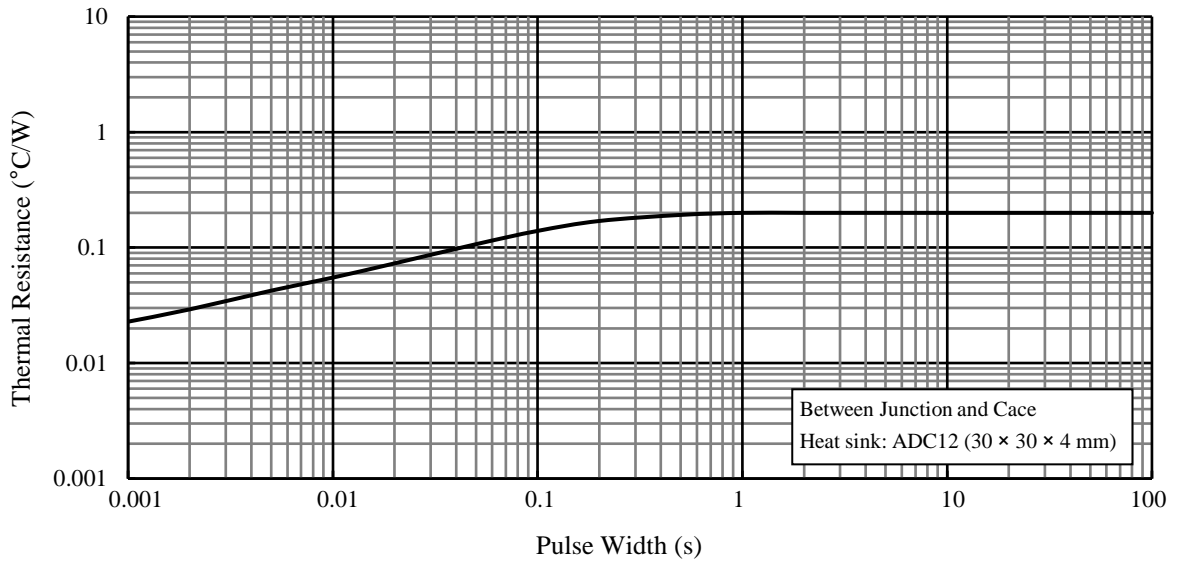

Figure 22. Typical Transient Thermal Resistance⁽⁹⁾

⁽⁹⁾ See Figure 1 for the measurement conditions of lead temperature.

SG-C17xxZ27

Physical Dimensions

- Pressfit

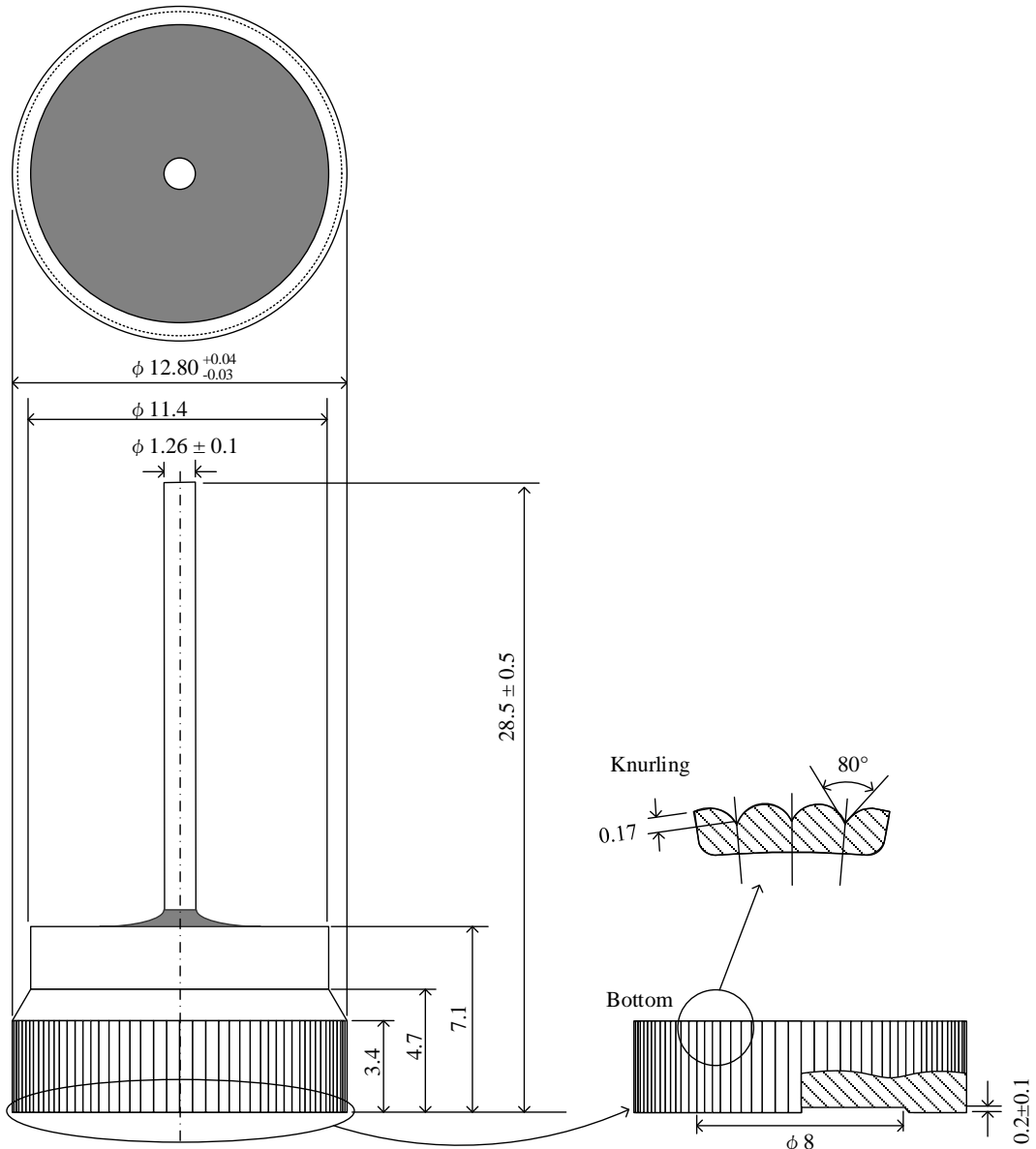

NOTES:

- Dimensions in millimeters
- Knurling number: 78
- Lead treatment: Pb-free (RoHS compliant)
- Must be pressfit into the heatsink when used.
- Dimensions without tolerances have a tolerance of ± 0.2 .

● **Heatsink**

- Recommended hole size and interference: See Figure 23
- Recommended heatsink material: ADC12 or the aluminum die-casting that has same characteristics as ADC12
- Recommended heatsink material strength: 140 to 160 Hv

● **How to Pressfit**

Note followings when the product is pressed into the heatsink.

- Press pin contact area: See Figure 24 (The press pin must not be pressed to “No press area”)
- Recommended press pin form: See Figure 25
- Contact area between the press pin and the product: $\geq 30 \text{ mm}^2$ (If the contact area is too small, the product package is deformed and the product damage may be caused.)
- Maximum press load: $\leq 10,000 \text{ N}$ (See Figure 26)

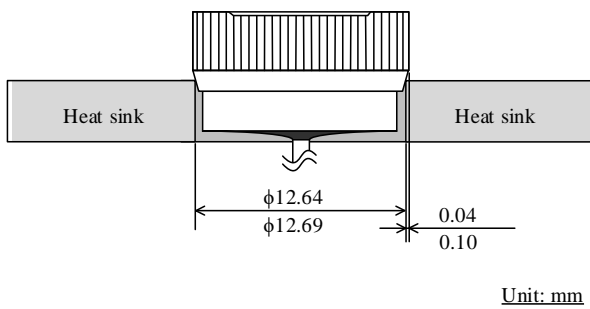

Figure 23 Recommended Hole Size and Interference

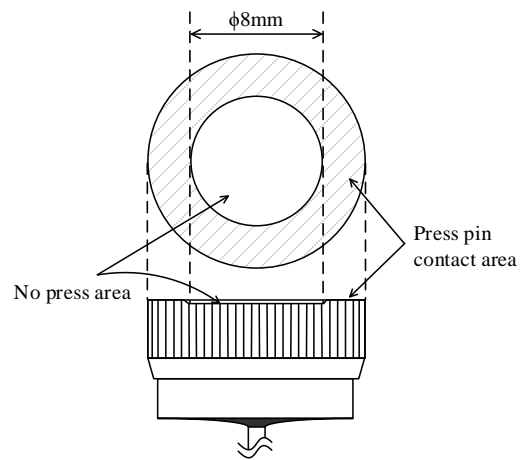

Figure 24 Press Pin Contact Area

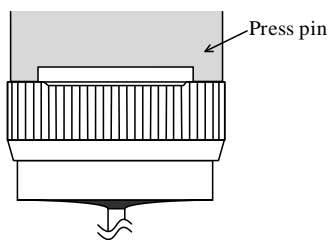

Figure 25 Recommended Press Pin Form

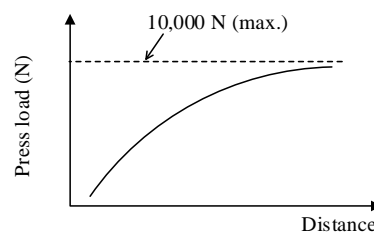

Figure 26 Maximum Press Load

Marking Diagram

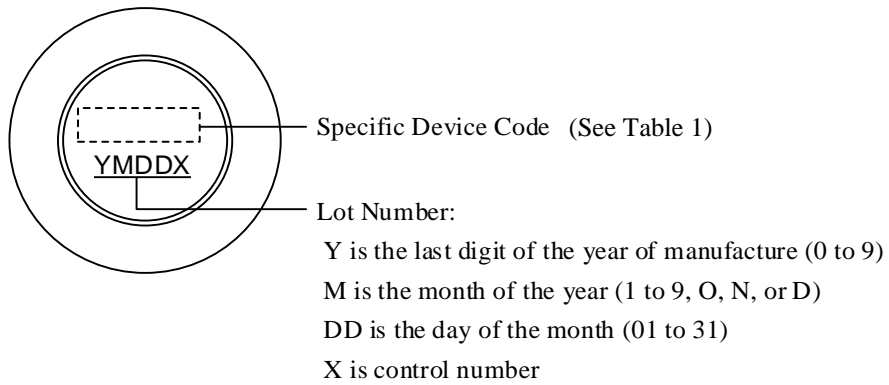

Table 1. Specific Device Code

Specific Device Code	Part Number
AC27S	SG-C17LXZ27S
AC27R	SG-C17LXZ27R
BC27S	SG-C17VLZ27S
BC27R	SG-C17VLZ27R
DC27S	SG-C17VVZ27S
DC27R	SG-C17VVZ27R
HC27S	SG-C17WVZ27S
HC27R	SG-C17WVZ27R

Important Notes

- All data, illustrations, graphs, tables and any other information included in this document (the “Information”) as to Sanken’s products listed herein (the “Sanken Products”) are current as of the date this document is issued. The Information is subject to any change without notice due to improvement of the Sanken Products, etc. Please make sure to confirm with a Sanken sales representative that the contents set forth in this document reflect the latest revisions before use.
- The Sanken Products are intended for use as components of electronic equipment or apparatus (transportation equipment and its control systems, home appliances, office equipment, telecommunication equipment, measuring equipment, etc.). Prior to use of the Sanken Products, please put your signature, or affix your name and seal, on the specification documents of the Sanken Products and return them to Sanken. If considering use of the Sanken Products for any applications that require higher reliability (traffic signal control systems or equipment, disaster/crime alarm systems, etc.), you must contact a Sanken sales representative to discuss the suitability of such use and put your signature, or affix your name and seal, on the specification documents of the Sanken Products and return them to Sanken, prior to the use of the Sanken Products. The Sanken Products are not intended for use in any applications that require extremely high reliability such as: aerospace equipment; nuclear power control systems; and medical equipment or systems, whose failure or malfunction may result in death or serious injury to people, i.e., medical devices in Class III or a higher class as defined by relevant laws of Japan (collectively, the “Specific Applications”). Sanken assumes no liability or responsibility whatsoever for any and all damages and losses that may be suffered by you, users or any third party, resulting from the use of the Sanken Products in the Specific Applications or in manner not in compliance with the instructions set forth herein.
- In the event of using the Sanken Products by either (i) combining other products or materials or both therewith or (ii) physically, chemically or otherwise processing or treating or both the same, you must duly consider all possible risks that may result from all such uses in advance and proceed therewith at your own responsibility.
- Although Sanken is making efforts to enhance the quality and reliability of its products, it is impossible to completely avoid the occurrence of any failure or defect or both in semiconductor products at a certain rate. You must take, at your own responsibility, preventative measures including using a sufficient safety design and confirming safety of any equipment or systems in/for which the Sanken Products are used, upon due consideration of a failure occurrence rate and derating, etc., in order not to cause any human injury or death, fire accident or social harm which may result from any failure or malfunction of the Sanken Products. Please refer to the relevant specification documents and Sanken’s official website in relation to derating.
- No anti-radioactive ray design has been adopted for the Sanken Products.
- The circuit constant, operation examples, circuit examples, pattern layout examples, design examples, recommended examples, all information and evaluation results based thereon, etc., described in this document are presented for the sole purpose of reference of use of the Sanken Products.
- Sanken assumes no responsibility whatsoever for any and all damages and losses that may be suffered by you, users or any third party, or any possible infringement of any and all property rights including intellectual property rights and any other rights of you, users or any third party, resulting from the Information.
- No information in this document can be transcribed or copied or both without Sanken’s prior written consent.
- Regarding the Information, no license, express, implied or otherwise, is granted hereby under any intellectual property rights and any other rights of Sanken.
- Unless otherwise agreed in writing between Sanken and you, Sanken makes no warranty of any kind, whether express or implied, including, without limitation, any warranty (i) as to the quality or performance of the Sanken Products (such as implied warranty of merchantability, and implied warranty of fitness for a particular purpose or special environment), (ii) that any Sanken Product is delivered free of claims of third parties by way of infringement or the like, (iii) that may arise from course of performance, course of dealing or usage of trade, and (iv) as to the Information (including its accuracy, usefulness, and reliability).
- In the event of using the Sanken Products, you must use the same after carefully examining all applicable environmental laws and regulations that regulate the inclusion or use or both of any particular controlled substances, including, but not limited to, the EU RoHS Directive, so as to be in strict compliance with such applicable laws and regulations.
- You must not use the Sanken Products or the Information for the purpose of any military applications or use, including but not limited to the development of weapons of mass destruction. In the event of exporting the Sanken Products or the Information, or providing them for non-residents, you must comply with all applicable export control laws and regulations in each country including the U.S. Export Administration Regulations (EAR) and the Foreign Exchange and Foreign Trade Act of Japan, and follow the procedures required by such applicable laws and regulations.
- Sanken assumes no responsibility for any troubles, which may occur during the transportation of the Sanken Products including the falling thereof, out of Sanken’s distribution network.
- Although Sanken has prepared this document with its due care to pursue the accuracy thereof, Sanken does not warrant that it is error free and Sanken assumes no liability whatsoever for any and all damages and losses which may be suffered by you resulting from any possible errors or omissions in connection with the Information.
- Please refer to our official website in relation to general instructions and directions for using the Sanken Products, and refer to the relevant specification documents in relation to particular precautions when using the Sanken Products.
- All rights and title in and to any specific trademark or tradename belong to Sanken and such original right holder(s).

DSGN-AEZ-16003