

# High Voltage Full Bridge Drive ICs SLA2402MS

## ■Features

- One Package Full Bridge Driver Consisted of High Voltage IC and Power MOSFETs(4 pieces)
- High Voltage Driver which accepts direct connection to the input signal line
- External components such as high voltage diodes and capacitors are not required

## ■Absolute Maximum Ratings

Parameter	Symbol	Ratings	Unit	Conditions
Power source voltage *	$V_M$	500	V	
Input voltage	$V_{IN}$	15	V	
Output voltage	$V_O$	500	V	
Output current	$I_O$	15	A	$P_W \leq 250\mu s$
Power dissipation	$P_D$	5 ( $T_a=25^\circ C$ )	W	Without heatsink
Storage temperature	$T_{stg}$	-40 to +125	$^\circ C$	
Operation temperature	$T_{opr}$	-40 to +105	$^\circ C$	

\* Power GND (D terminal) to -HV (-HV terminal) voltage.

## ■Electrical Characteristics

Parameter	Symbol	Ratings			Unit	Conditions
		min	typ	max		
Power MOS FET output breakdown voltage	$BV_{OUT}$	500			V	$I_O=100\mu A$
Power MOS FET output leakage voltage	$I_{OUT(off)}$			100	$\mu A$	$V_O=500V$
High-side Power MOS FET output on-state voltage	$V_{OUT(on)1}$	0.28	0.4	0.52	V	$I_O=0.4A, V_{IN}=10V$
	$V_{OUT(on)2}$	1.4	2.0	2.6	V	$I_O=2A, V_{IN}=10V$
Low-side Power MOS FET output on-state voltage	$V_{OUT(on)1}$	0.28	0.4	0.52	V	$I_O=0.4A, V_{GL}=10V$
	$V_{OUT(on)2}$	1.4	2.0	2.6	V	$I_O=2A, V_{GL}=10V$
Quiescent circuit current	$I_{CC1}$			3.0	mA	$V_{CC}=4.5$ to $15V$
	$I_{CC2}$			4.0	mA	$V_{CC}=10V, V_M=400V$
Operating circuit current	$I_{CC3}$			4.0	mA	$V_{CC}=10V, V_M=400V$
Input voltage (High level)	$V_{IH}$	$0.8V_{CC}$			V	$V_{CC}=4.5$ to $15V$
Input voltage (Low level)	$V_{IL}$			$0.2V_{CC}$	V	$V_{CC}=4.5$ to $15V$
Delay time *	$t_d(on)$		1.4		$\mu s$	$V_{CC}=10A, V_{IN}=10V, V_M=85A, I_O=0.41A$
	$t_d(off)$		3.3		$\mu s$	
	$\Delta t$			2.5		$\mu s$
Operating voltage	$V_{CC}$			15	V	-40 to +105 $^\circ C$

\* About delay time

Signal input waveform vs output waveform

① Highside switch turn-on, turn-off

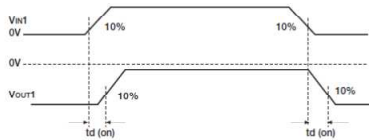

② Lowside switch turn-on, turn-off

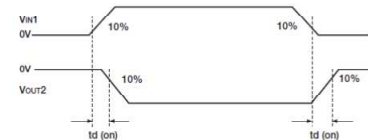

\*  $\Delta t: \Delta t = t_d(on) - t_d(off)$

Measurement Circuit

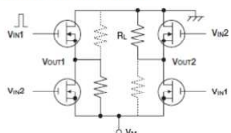

Conditions  
 $V_{CC}=10V, V_{IN}=10V$  (pulse)  
 $V_M=85V$   
 $I_O=0.41A$  ( $R_L=207\Omega$ )

\* When pulse signal is inputted to  $V_{IN1}$ ,  $R_L$  on solid line is ON and dotted line  $R_L$  is off.  
 On the contrary, when pulse signal is inputted to  $V_{IN2}$ ,  $R_L$  on dotted line is ON and solid line  $R_L$  is off.

## ■External Dimensions (unit:mm)

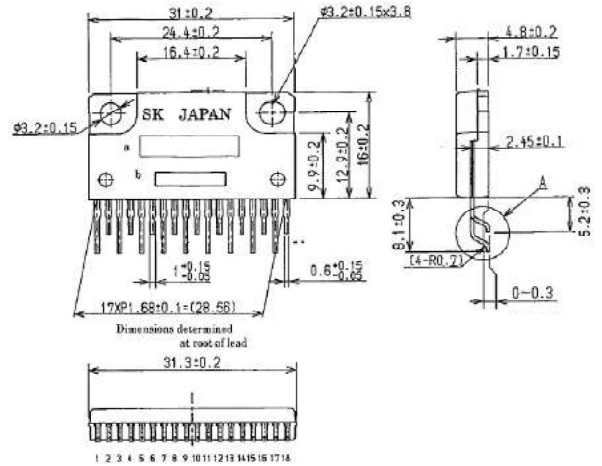

## ■Block Diagram

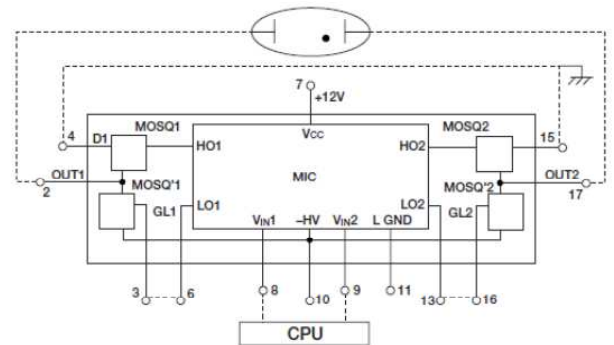

\* Dotted Line: Outside Connection

## ■Timing Chart

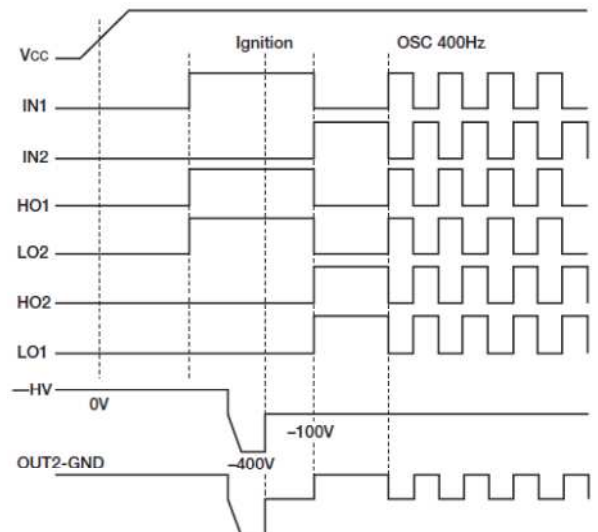

# Electrical Characteristics

■ Quiescent circuit current

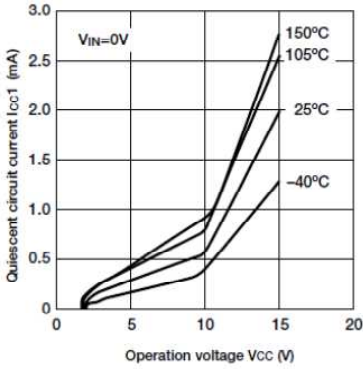

■ Quiescent circuit current supplied high voltage

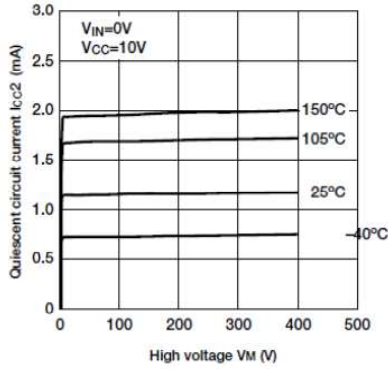

■ Operating circuit current

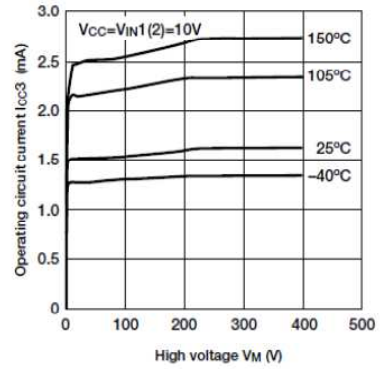

■ Quiescent circuit current supplied high voltage

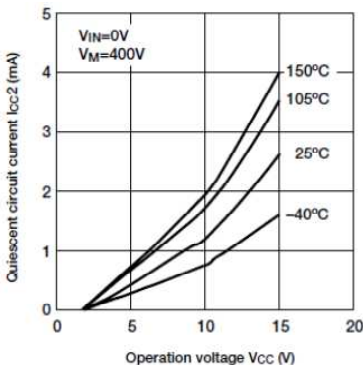

■ Quiescent circuit current

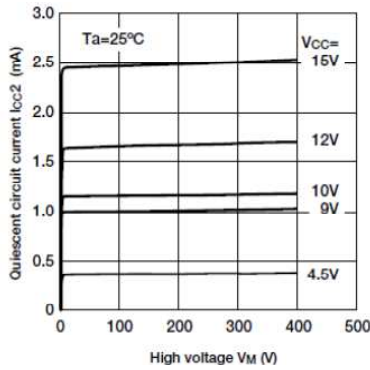

■ Operating circuit current

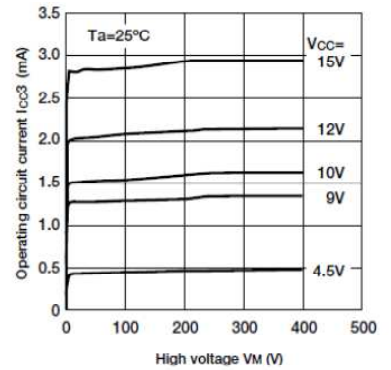

■ Output on-state voltage

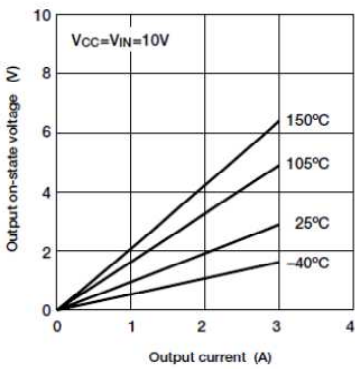

■ Gate drive voltage

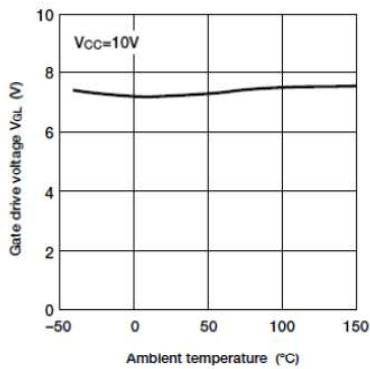

■ Gate drive voltage

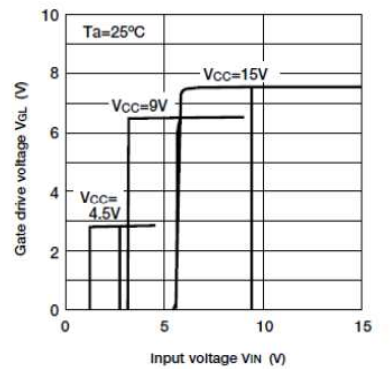

■ Output on-state voltage

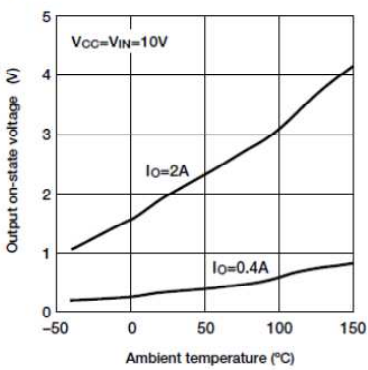

■ Input threshold voltage

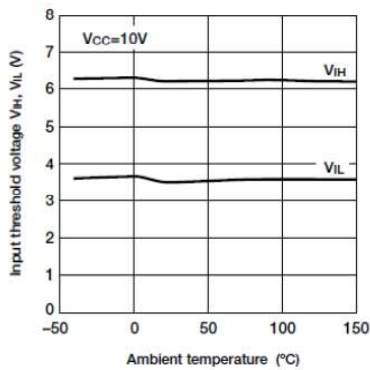

# Electrical Characteristics

High side switch turn-on, off

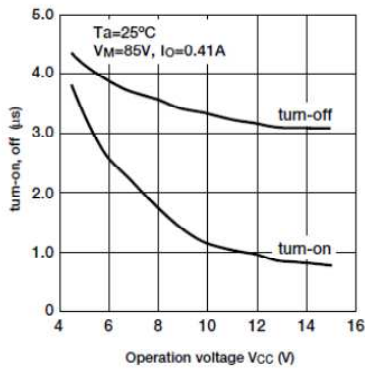

High side switch turn-on, off

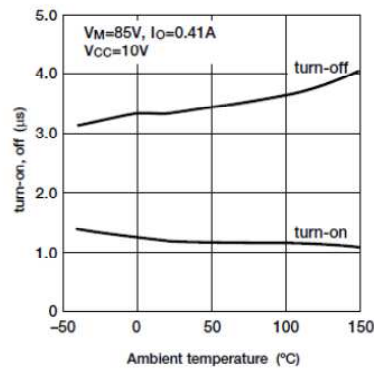

Low side switch turn-on, off

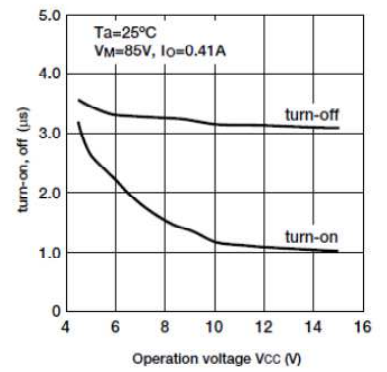

Low side switch turn-on, off

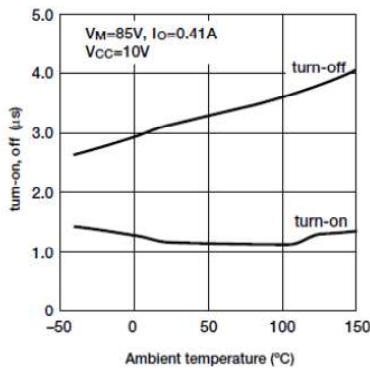

Transient thermal resistance characteristics

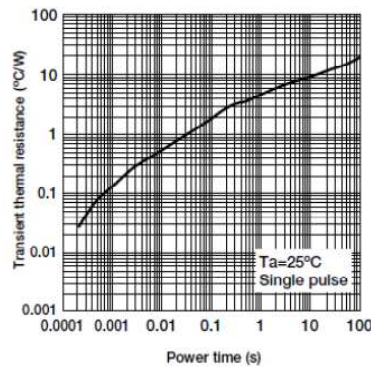

Safe operating area (Power MOS FET)

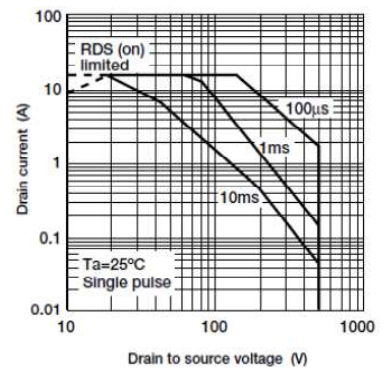

Power derating curve

